

TEKNIC

Motor Protective Circuit Breaker, TMP, MS



Content	Page No.
Motor-Protective Circuit Breakers (MPCBs)	1
Motor-Protective Circuit Breaker TMP Operation and Protection of Motors	2
Motor Protective Circuit Breakers TMP - Overview	3
Motor Protective Circuit Breakers TMP16 - Overview	4
Motor Protective Circuit Breakers TMP16 - Selection Table	5
Motor Protective Circuit Breakers TMP25 - Overview	6
Motor Protective Circuit Breakers TMP25 - Selection Table	7
Motor Protective Circuit Breakers TMP65 - Overview	8
Motor Protective Circuit Breakers TMP65 - Selection Table	9
Motor Protective Circuit Breakers TMP - Accessories	10
Motor Protective Circuit Breakers TMP - Accessories	11
Motor Protective Circuit Breakers TMP - Accessories	12
Motor Protective Circuit Breakers TMP - Accessories	13
Motor Protective Circuit Breakers TMP - Technical Data	14
Motor Circuit Breakers TMP - Technical Data	15
Motor Protective Circuit Breakers TMP - Technical Data	16
Motor Protective Circuit Breakers TMP - Technical Data	17
Motor Protective Circuit Breakers TMP25 - Coordination Tables	18
Motor Protective Circuit Breakers TMP25 - Coordination Tables	19
Motor Protective Circuit Breakers TMP - Rated Short-Circuit Breaking	20
Motor Protective Circuit Breakers TMP - Characteristics Curves	21
Motor Protective Circuit Breakers TMP - Rated Short-Circuit Breaking	22
Motor Protective Circuit Breakers TMP - Tripping Characteristic Curves	23
Connection Diagrams and Typical Circuits	24
Motor Protective Circuit Breakers TMP - Dimensions (mm)	25
Motor Protective Circuit Breakers TMP - Dimensions (mm)	26
Motor Protective Circuit Breakers TMP - Dimensions (mm)	27
Motor Protective Circuit Breakers TMP - Dimensions (mm)	28
Motor Protective Circuit Breakers TMP - Dimensions (mm)	29
Product-System Motor-Protective Circuit Breakers MS - Overview	30
Motor-Protective Circuit Breaker MS	31
Motor-Protective Switch (thermal only) BS	32
Motor-Protective Circuit Breaker MSH for single phase motors	33
Protective Switch, (control) transformer protection, MST	34
Accessories	35-39
Technical Data	40
Technical Drawing	41
Nominal rated motor currents	42
Motor-protective Circuit Breaker - Technical Data	43
Other Products available	44

Motor-Protective Circuit Breakers (MPCBs)

Introduction

Motor Protective Circuit Breakers (MPCBs) combine motor control and protection in a single device and are used as protection devices for the main circuit.

MPCBs are mainly used to manually switch motors ON/OFF. MPCB are fuseless installation and protect motors and equipments against short circuit, overload and phase failures. They are cost effective and saves space and ensures a quick reaction under short-circuit condition, by switching off the motor within milliseconds.

Motor Protective Circuit Breakers (MPCB) can be equipped with many other accessories. Connection links ensure that the Motor Protective Circuit Breaker can be connected wire free to many Block Contactors and Soft starters easily.

MPCB Type MS (0.1A – 32A)

We have been supplying to our Indian customers, Motor Protective Circuit Breaker type MS, carrying international approvals like UL & VDE, providing an optimum protection for electrical motors and equipments up to 32 amps. Specifications of our MPCBs, type MS are separately covered in our catalogue on "Motor Protective Circuit Breakers MS".

Our new range Type TMP (0.1A – 65A) ; TMP (55A-100A)**

For a long time, our customers have been requesting us for MPCB with a much wider current rating as well as higher Short Breaking Capacity. We now have pleasure in announcing our new range of MPCBs type "TMP", available in three models TMP16, TMP25 & TMP65. The new range of our MPCB Type TMP covers upto a rating of 65 amps for motor protection upto 30kW 400V with a short circuit breaking capacity Ics of 50kA.

These have been designed for use according to international standards and are CE certified and carry approvals like UL and CSA.

** TMP (55A-100A)- For this model technical data will be available on request.

Main Characteristics of our MPCB Type TMP:

- Overload Protection – trip class 10
- Phase failure sensitiveness
- Disconnect function for safety isolation of the installation and the supply
- Temperature compensation from -25... + 60°C
- Adjustable current setting for overload protection
- Suitable for three and single phase application
- Trip-free mechanism
- Lockable handle

Available accessories

- Auxiliary contacts for side mounting
- Auxiliary contacts for front mounting
- Undervoltage release
- Shunt trips
- 3-phase bus bars
- Power in-feed blocks
- Locking devices
- Enclosures
- Door mounting kit
- Trip signaling Block
- Current Limitor

We hope this detailed catalogue on our new range of MPCBs type TMP, covering various model TMP16, TMP25 & TMP65 gives full technical details, satisfying our customers request for a wider range to satisfy different applications. All models namely MS, TMP16, TMP25 & TMP65 with their individual technical details are integrated into this new catalogue.

Product-System Motor-Protective Circuit Breaker TMP Operation and Protection of Motors

Models-Push Button, Rotary Handle.

Models TMP16, TMP 25, TMP 65







Motor Protective Circuit Breakers TMP - Overview

With the latest technology and design, the TMP series saves panel space and can be used in most applications in motor control.

It combines short-circuit and motor overload protections in just one component. These devices are operated in ON-TRIP-OFF position with facility for padlocking in OFF position.

Designed for DIN rail mounting, while lugs for direct panel mounting are also available as accessory.

TMP Motor Protective Circuit Breakers are available in three models: TMP16/TMP25 (45mm) & TMP65 (54mm) and have been designed for use according to international standards, making them suitable for applications all over the world.

		TMP16 up to 16A	TMP25 up to 32A	TMP65 up to 65A	
					
General Technical Data	Maximum Rated Current $I_{max}(I_u)$	16A	32A	65A	
	Number of poles	3	3	3	
	Short-Circuit release	$13 \times I_u \text{ max}$	$13 \times I_u \text{ max}$	$13 \times I_u \text{ max}$	
	Rated Operational Voltage U_o	690V	690V	690V	
	Rated Frequency	50/60Hz	50/60Hz	50/60Hz	
	Utilization category	IEC 60 947-2 (Circuit Breaker)	A	A	A
		IEC 60 947-4-1 (Motor starter)	AC-3	AC-3	AC-3
	Tripping Test	Yes	Yes	Yes	
	Overload Protection	Yes	Yes	Yes	
	Phase failure sensitivity	Yes	Yes	Yes	
	Tripping Indication	Yes	Yes	Yes	
	Tripping Class	10	10	10	
	Mechanical life	Number of operations	100,000	100,000	50,000
	Electrical life	Number of operations	100,000	100,000	25,000
	Temperature compensation		-20...+60°C	-20...+60°C	-20...+60°C
Type of protection		Thermal-magnetic	Thermal-magnetic	Thermal-magnetic	
Setting overload release  $I_r(A)$		Reference code	Reference code	Reference code	
0.1...0.16		TMP16-3-C016	TMP25-3-C016		
0.16...0.25		TMP16-3-C025	TMP25-3-C025		
0.25...0.4		TMP16-3-D004	TMP25-3-D004		
0.4...0.63		TMP16-3-C063	TMP25-3-C063		
0.63...1		TMP16-3-U001	TMP25-3-U001		
1...1.6		TMP16-3-D016	TMP25-3-D016		
1.6...2.5		TMP16-3-D025	TMP25-3-D025		
2.5...4		TMP16-3-U004	TMP25-3-U004		
4...6.3		TMP16-3-D063	TMP25-3-D063		
6.3...10		TMP16-3-U010	TMP25-3-U010		
10...16		TMP16-3-U016	TMP25-3-U016	TMP65-3-U016	
16...20			TMP25-3-U020	TMP65-3-U020	
20...25			TMP25-3-U025	TMP65-3-U025	
25...32			TMP25-3-U032	TMP65-3-U032	
32...40				TMP65-3-U040	
40...50				TMP65-3-U050	
50...65				TMP65-3-U065	

Motor Protective Circuit Breakers TMP16 - Overview

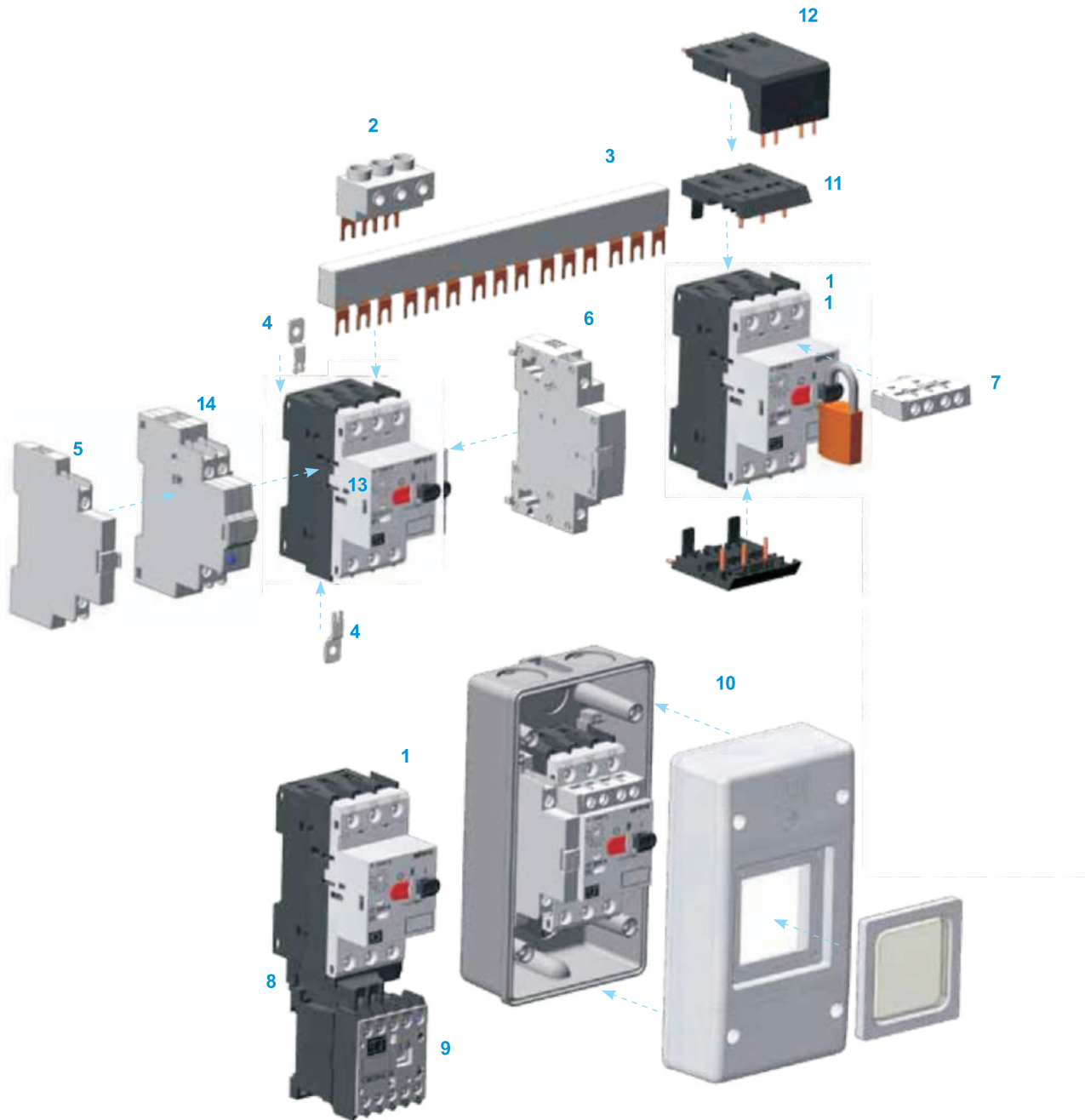

- 1 - Motor protective circuit breaker TMP16
- 2 - Feeder terminal
- 3 - Three-phase commoning block TBBS
- 4 - Push-in-lugs
- 5 - Side auxiliary contact block TACBS
- 6 - Undervoltage release TURMP or shunt release TSRMP
- 7 - Front auxiliary contact block TACBF
- 8 - Connector TECCMP-C016 (TMP16 + TCC07...16)
- 9 - Mini contactors TCC 07...16
- 10 - Insulated enclosure
- 11 - Block module for power terminals to printed circuit board
- 12 - Block module for auxiliary frontal contact block to printed circuit board
- 13 - Scale cover SCMP
- 14 - Trip signalling block TTSB

Motor Protective Circuit Breakers TMP16 - Selection Table

- With overload and short circuit protection
- Fixed short circuit release $13 x I_n$
- With phase-failure sensitivity according to IEC/EN 60947-4-1/DIN VDE 0660 T.102
- With temperature compensation
- For use as main switch
- TMP16 up to 6,3 A at 400/415 V are self protected
- TMP16 fulfill UL/CSA



Motor Protective Circuit Breaker TMP16 - Thermal-magnetic

Reference table for selecting protection of three-phase motor 50/60Hz - 4 poles ¹⁾						Rated Current I_n (A)	Setting Overload Release I_r (A)	Instantaneous Magnetic Trip I_m (A)	Reference Code	Weight kg
220-240V hp / kW	380-415V hp / kW	440-480V hp / kW	500V hp / kW	550-600V hp / kW	690V hp / kW					
-	-	-	-	-	-	0.16	0.1...0.16	2.0	TMP16-3-C016	0.28
-	-	-	-	-	0.16 / 0.12	0.25	0.16...0.25	3.2	TMP16-3-C025	
-	-	0.16 / 0.12	0.16 / 0.12	0.16 / 0.12	0.25 / 0.18	0.4	0.25...0.4	5.2	TMP16-3-D004	
-	0.16 / 0.12	0.25 / 0.18	0.25 / 0.18	0.33 / 0.25	0.33 / 0.25	0.63	0.4...0.63	8.1	TMP16-3-C063	
0.16 / 0.12	0.33 / 0.25	0.33 / 0.25	0.5 / 0.37	0.5 / 0.37	0.75 / 0.55	1	0.63...1	13	TMP16-3-U001	
0.33 / 0.25	0.5 / 0.37	1 / 0.75	1 / 0.75	1 / 0.75	1.5 / 1.1	1.6	1...1.6	20.8	TMP16-3-D016	
0.5 / 0.37	1 / 0.75	1.5 / 1.1	1.5 / 1.1	1.5 / 1.1	2 / 1.5	2.5	1.6...2.5	32.5	TMP16-3-D025	
1 / 0.75	2 / 1.5	2 / 1.5	2 / 1.5	3 / 2.2	4 / 3	4	2.5...4	52	TMP16-3-U004	
1.5 / 1.1	3 / 2.2	4 / 3	4 / 3	5 / 3.7	5.5 / 4	6.3	4...6.3	81.9	TMP16-3-D063	
3 / 2.2	6 / 4.5	7.5 / 5.5	5.5 / 4	7.5 / 5.5	10 / 7.5	10	6.3...10	130	TMP16-3-U010	
5 / 3.7	10 / 7.5	12.5 / 9.2	12.5 / 9.2	15 / 11	15 / 11	16	10...16	208	TMP16-3-U016	

Note: 1) Some motors characteristics may vary according to each manufacturer

Motor Protective Circuit Breakers TMP25 - Overview

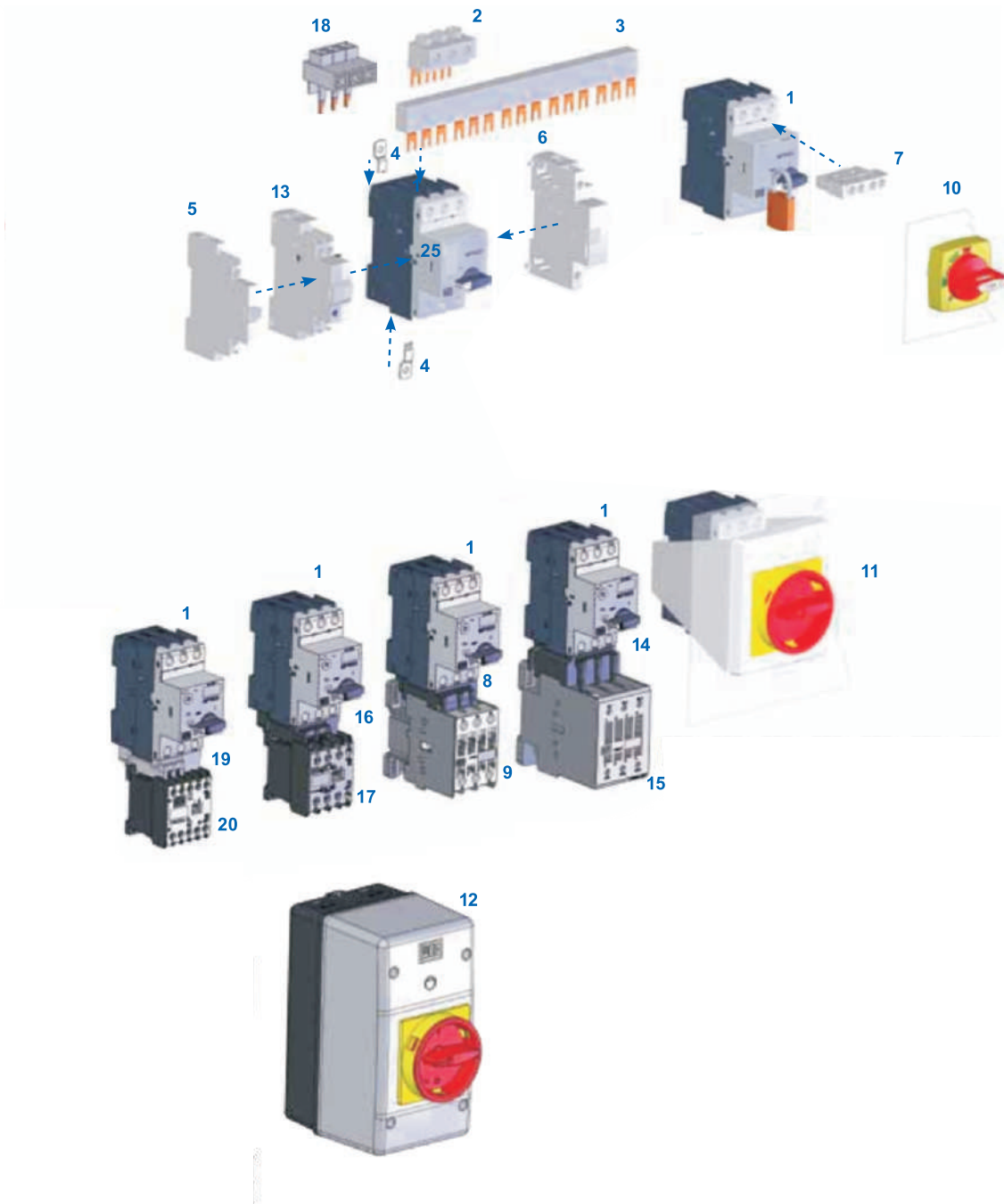

- | | |
|---|---|
| 1 - Motor protective circuit breaker TMP25 | 12 - Standard insulated enclosure TMPE55 |
| 2 - Feeder terminal | 13 - Trip signalling block TTSB |
| 3 - Three-phase commoning block TBBS | 14 - Connector TECCMP-32 (TMP25 + TCM32...40) |
| 4 - Push-in-lugs | 15 - Contactors TCM32...40 |
| 5 - Side auxiliary contact block TACBS | 16 - Connector TECCMP-C025 (TMP25 + TCC025) |
| 6 - Undervoltage release TURMP or shunt release TSRMP | 17 - Mini contactor TCC025 |
| 7 - Front auxiliary contact block TACBF | 18 - Feeder terminal for "Type E" motor starter according to UL LST25 |
| 8 - Connector TECCMP-25 (TMP25 + TCM9...25) | 19 - Connector TECCMP-C0 (TMP25 + TCC07...16) |
| 9 - Contactors TCM9...25 | 20 - Mini contactor TCC07...16 |
| 10 - Door coupling rotary handle TMRX | 21 - Scale cover SCMP |
| 11 - Front plate | |

Motor Protective Circuit Breakers TMP25 - Selection Table

- With overload and short circuit protection
- Fixed short circuit release $13 \times I_n$
- With phase-failure sensitivity according to IEC/EN 60947-4-1/DIN VDE 0660 T.102
- With temperature compensation
- For use as main switch
- TMP25 up to 10 A at 400/415 V are self protected
- TMP25 fulfill UL/CSA



Motor Protective Circuit Breaker TMP25 - Thermal-magnetic

Reference table for selecting protection of three-phase motor 50/60Hz - 4 poles ¹⁾						Rated Current I_n (A)	Setting Overload Release I_r (A)	Instantaneous Magnetic Trip I_m (A)	Reference Code	Weight kg
220-240V hp / kW	380-415V hp / kW	440-480V hp / kW	500V hp / kW	550-600V hp / kW	690V hp / kW					
-	-	-	-	-	-	0.16	0.1...0.16	1.9	TMP25-3-C016	0.36
-	-	-	-	-	0.16 / 0.12	0.25	0.16...0.25	3.0	TMP25-3-C025	
-	-	0.16 / 0.12	0.16 / 0.12	0.16 / 0.12	0.25 / 0.18	0.4	0.25...0.4	4.8	TMP25-3-D004	
-	0.16 / 0.12	0.25 / 0.18	0.25 / 0.18	0.33 / 0.25	0.33 / 0.25	0.63	0.4...0.63	7.5	TMP25-3-C063	
0.16 / 0.12	0.33 / 0.25	0.33 / 0.25	0.5 / 0.37	0.5 / 0.37	0.75 / 0.55	1	0.63...1	12	TMP25-3-U001	
0.33 / 0.25	0.5 / 0.37	1 / 0.75	1 / 0.75	1 / 0.75	1.5 / 1.1	1.6	1...1.6	19	TMP25-3-D016	
0.5 / 0.37	1 / 0.75	1.5 / 1.1	1.5 / 1.1	1.5 / 1.1	2 / 1.5	2.5	1.6...2.5	30	TMP25-3-D025	
1 / 0.75	2 / 1.5	2 / 1.5	2 / 1.5	3 / 2.2	4 / 3	4	2.5...4	48	TMP25-3-U004	
1.5 / 1.1	3 / 2.2	4 / 3	4 / 3	5 / 3.7	5.5 / 4	6.3	4...6.3	75	TMP25-3-D063	
3 / 2.2	6 / 4.5	7.5 / 5.5	5.5 / 4	7.5 / 5.5	10 / 7.5	10	6.3...10	120	TMP25-3-U010	
5 / 3.7	10 / 7.5	12.5 / 9.2	12.5 / 9.2	15 / 11	15 / 11	16	10...16	190	TMP25-3-U016	
7.5 / 5.5	12.5 / 9.2	15 / 11	15 / 11	-	20 / 15	20	16...20	240	TMP25-3-U020	
-	15 / 11	-	20 / 15	20 / 15	25 / 18.5	25	20...25	300	TMP25-3-U025	
12.5 / 9.2	20 / 15	20 / 15	25 / 18.5	30 / 22	30 / 22	32	25...32	384	TMP25-3-U032	

Note: 1) Some motors characteristics may vary according to each manufacturer

Motor Protective Circuit Breakers TMP65 - Overview

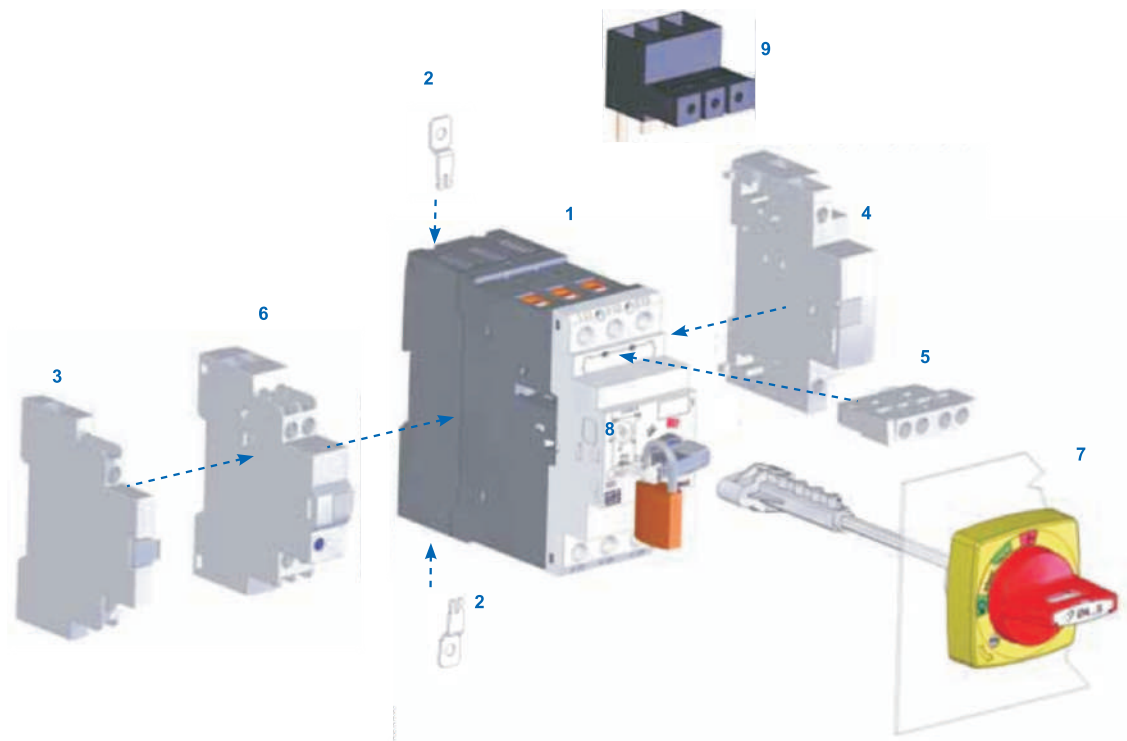

- 1 - Motor protective circuit breaker TMP65
- 2 - Push-in-lugs PLMP
- 3 - Side auxiliary contact block TACBS
- 4 - Undervoltage release TURMP or shunt release TSRMP
- 5 - Frontal auxiliary contact block TACBF
- 6 - Trip signalling block TTSB
- 7 - Door coupling rotary handle TMRX65
- 8 - Scale cover SCMP
- 9 - Feeder terminal for "Type E" motor starter according to UL LST65

Motor Protective Circuit Breakers TMP65 - Selection Table

- With overload and short circuit protection
- Fixed short circuit release $13 \times I_n$
- With phase-failure sensitivity according to IEC/EN 60947-4-1/DIN VDE 0660 T.102
- With temperature compensation
- For use as main switch
- TMP65 provides a breaking capacity of 50 kA at 400/415 V according to IEC/EN 60947-2
- TMP65 fulfill UL/CSA



Motor Protective Circuit Breaker TMP65 - Thermal-magnetic

Reference table for selecting protection of three-phase motor 50/60Hz - 4 poles ¹⁾						Rated Current I_n (A)	Setting Overload Release I_r (A)	Instantaneous Magnetic Trip I_{rm} (A)	Reference Code	Weight kg
220-240V hp / kW	380-415V hp / kW	440-480V hp / kW	500V hp / kW	550-600V hp / kW	690V hp / kW					
15 / 11	25 / 18.5	30 / 22	30 / 22	-	50 / 37	40	32...40	520	TMP65-3-U040	
-	30 / 22	40 / 30	40 / 30	50 / 37	60 / 45	50	40...50	650	TMP65-3-U050	
25 / 18.5	40 / 30	50 / 37	60 / 45	60 / 45	75 / 55	65	50...65	845	TMP65-3-U065	

Note: 1) Some motors characteristics may vary according to each manufacturer

Front Auxiliary Contact Block - TACBF

For use with	Illustrative picture	Auxiliary Contacts		Reference Code	Weight kg
		NO	NC		
TMP16 TMP25 TMP65		1	1	TACBF-11	0.024

Left side auxiliary contact block - TACBS

For use with	Illustrative picture	Auxiliary Contacts		Reference Code	Weight kg
		NO	NC		
TMP16 TMP25 TMP65		1	1	TACBS-11	0.045
		2	-	TACBS-20	
		-	2	TACBS-02	

Note: 1) The following accessories can be assembled at the same time: 1 TACBF + 1 TURMP/TSRMP + 1 TTSB or 1 TACBS + 1 TURMP/TSRMP + 1 TTSB

Trip Signalling Block - TTSB

For use with	Illustrative picture	Description	Reference Code	Weight kg
TMP16 TMP25 TMP65		<p>-Equipped with 2 auxiliary contacts (1NO + 1NC) for overload trip signalling and 2 other auxiliary contacts (1NO + 1NC) for short-circuit trip signalling.</p> <p>- To reset the circuit breaker after a short-circuit, the flag must be manually reset after the cause of the failure has been solved.</p> <p>- Lateral auxiliary contacts can be assembled together with the trip signalling block.</p> <p>- Left side assembly only</p>	TTSB	0,130

Undervoltage Release - TURMP

For use with	Illustrative picture	Voltage ²⁾	Reference Code	Weight kg
TMP16 TMP25 TMP65	 <p>Note: - Operating voltage > 0,85 x Ue - Non operating voltage 0,35...0,7 x Ue</p>	230-240V 50Hz / 277V 60Hz 400-415V 50Hz / 480V 60Hz	TURMP V37 TURMP V47	0,130



Notes: 1) The following accessories can be coupled at the same time: 1 TACBF 1 TURMP/TSRMP + 1 TTSB or 1 TACBS + 1 TURMP/TSRMP 1 TTSB
2) Other voltages available.

Shunt Release - TSRMP



For use with	Illustrative picture	Voltage ²⁾	Reference Code	Weight kg
TMP16 TMP25 TMP65	 <p>Note: - Operating voltage > 0.7 x U_e</p>	200-240V 50/60Hz	TSRMP D65	0.130

Notes: 1) The following accessories can be coupled at the same time: 1 TACBF + 1 TURMP/TSRMP + 1 TTSB or 1 TACBS + 1 TURMP/TSRMP + 1 TTSB
2) Other voltages available

Door Coupling Rotary Handle - TMR

For use with	Illustrative picture	Description	Handle color	Reference Code	Weight kg
TMP25		<ul style="list-style-type: none"> - Panel door can be opened in ON position (thermometry) - Degree of protection: MRX = IP65/Nema 4X - Shows circuit breaker position "I"(ON) or "O"(OFF) - Adjustable shaft length. There are 2 standard shaft sizes: 130-155mm (Model 130) and 330-355mm (Model 330). To assemble the handle ON the circuit breaker the shaft must have a length of at least 80mm - Up to 3 padlocks can be used in the OFF position. This blocks circuit breaker operation and opens panel door Handle can be mounted on panels with a thickness of 1 to 5mm 	Black	TMRX-130	0,250
			Black	TMRX-330	
TMP65			Red/ Yellow	TMRX-130E	
			Red/ Yellow	TMRX-330E	
			Black	TMRX65-130	
			Black	TMRX65-330	
Red/ Yellow	TMRX65-130E				
Red/ Yellow	TMRX65-330E				

Standard Insulated Enclosure - TMPE

For use with	Illustrative picture	Description	Terminals	Handle color	Reference Code	Weight kg
TMP16		<ul style="list-style-type: none"> - Degree of protection: IP41 - Two M25 metric cable entry knockouts, top and bottom - Allows installing: TMP16 + TACBF11/PL lamps + TACBS 	With ground terminals	-	TMPE41G	0,510
		<ul style="list-style-type: none"> - Degree of protection: IP66 - Two M25 metric cable entry knockouts, top and bottom - Allows installing: TMP16 + TACBF11/PL lamps + TACBS 	With ground terminals	-	TMPE66G	0,510
TMP25		<ul style="list-style-type: none"> - Degree of protection: IP55 - For use on emergency-stop switches to IEC/EN 60204 - Allows installing: TMP25 + TACBF11/PL lamps + TACBS - Two M25 metric cable entry knockouts, top and bottom - Handle can be locked with up to 3 padlocks at OFF position. 	With ground terminals	Black	TMPE55G	0,510
				Red with yellow background	TMPE55GE	0,510

Reference Code		TMP16	TMP25
Maximum Rated Current $I_{max}(I)$		16A	32A
Number of poles		3	3
Instantaneous short-circuit		13 x I_{max} .	13 x I_{max} .
Rated operational voltage U_e		690V ¹⁾	690V ¹⁾
Rated operational frequency ²⁾		50/60Hz	50/60Hz
Insulation Voltage U_i		690V	690V
Rated impulse withstand voltage U_{imp}		6kV	6kV
Utilization category	IEC 60 947-2 (Circuit breaker)	A	A
	IEC 60 947-4-1 (Motor starter)	AC-3	AC-3
Tripping Test		Yes	Yes
Overload Protection		Yes	Yes
Phase failure sensitivity		Yes	Yes
Tripping indication		Yes	Yes
Tripping Class		10	10
Maximum operation per hour	Operations/hour	15	15
Altitude (m)		2000	2000
Degree of protection		IP20	IP20
Mechanical life span	Number of operations	100,000	100,000
Electrical life span	Number of operations	100,000	100,000
Ambient temperatures allowed			
Transport and storage		-50...+80°C	-50...+80°C
Operation ³⁾		-20...+70°C	-20...+70°C
Temperature compensation		-20...+60°C	-20...+60°C
Resistance to Impact (g)		15	15
Standards			
IEC/EN 60 947-1. DIN VDE 0660 (part 100)		Yes	Yes
IEC/EN 60 947-2. DIN VDE 0660 (part 101)		Yes	Yes
IEC/EN 60 947-4-1. DIN VDE 0660 (part 102)		Yes	Yes
Terminal capacity			
Type of terminal		Flat	Flat
Tightening torque	N.m	1.2...1.7	2...2.5
	lb.in	11...16	18...22
Type of screws		Philips (N°2)	Philips (N°2)
Dimensions			
Width (mm)		45	45
Height (mm)		90	97
Depth (mm)		77	98

Altitude - Correction factor

The TMP motor protective circuit breakers do not undergo any change to their specified performance when applied at an altitude of up to 2000 meters above sea level.

However, as the altitude increases, the atmospheric properties vary in terms of dielectric rigidity and pressure.

Therefore, current and voltage correction factors must be applied for altitudes exceeding 2000 meters, as shown in the table on the right:

Altitude (above sea level) - h	Rated operational voltage U_e	Current correction factor I_u
$h \leq 2000$ m	690 V	$1 \times I_u$
$2000 < h \leq 3000$ m	550 V	$0,96 \times I_u$
$3000 < h \leq 4000$ m	480 V	$0,93 \times I_u$
$4000 < h \leq 5000$ m	420 V	$0,90 \times I_u$

Notes: 1) 500V with plastic box;

2) On request: 0 to 400Hz

3) Reduce current for temperatures exceeding +60°C (87% to 70°C)

Reference Code	TMP65	
Maximum Rated Current $I_{max}(I_c)$	65A	
Number of poles	3	
Instantaneous short-circuit	$13 \times I_{cmax}$	
Rated operational voltage U_e	690V	
Rated operational frequency ¹⁾	50/60Hz	
Insulation Voltage U_i	690V	
Rated impulse withstand voltage U_{imp}	6kV	
Utilization category	IEC 60 947-2 (Circuit breaker)	A
	IEC 60 947-4-1 (Motor starter)	AC-3
Tripping Test	Yes	
Overload Protection	Yes	
Phase failure sensitivity	Yes	
Tripping indication	Yes	
Tripping Class	10	
Maximum operating frequency	Operations/hour	15
Altitude (m)	2000	
Degree of protection	IP20	
Mechanical life span	Number of operations	50,000
Electrical life span	Number of operations	25,000
Ambient temperatures allowed		
Transport and storage	-50...+80°C	
Operation ²⁾	-20...+70°C	
Temperature compensation	-20...+60°C	
Resistance to Impact (g)	15	
Standards		
IEC/EN 60 947-1, DIN VDE 0660 (part 100)	Yes	
IEC/EN 60 947-2, DIN VDE 0660 (part 101)	Yes	
IEC/EN 60 947-4-1, DIN VDE 0660 (part 102)	Yes	
Terminal capacity		
Type of terminal	Box	
Tightening torque	N.m	4...6
	lb.in	35...55
Type of screws	Allen (4mm)	
Dimensions		
Width (mm)	54	
Height (mm)	125	
Depth (mm)	157	

DC operation

The TMP16, TMP25 and TMP65 motor protective circuit breakers can also be used for operating continuous current loads. For such operation it is necessary to connect 2 or 3 poles in series.

See recommended circuits and their voltage limits in the table on the right.

Time constant $t = 5 \text{ ms}$

Short-circuit breaking capacity $I_{cu} = 10 \text{ kA}$ for all configurations

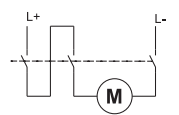
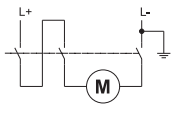
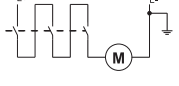
Circuits	Max. VDC	Notes
	150 VDC	System not grounded 2 pole series connected
	300 VDC	System grounded 2 pole series connected
	450 VDC	System grounded 3 pole series connected

Notes: 1) On request: 0 to 400Hz

2) Reduce current for temperatures exceeding +60°C (87% to 70°C)

Main Terminal Capacity

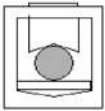
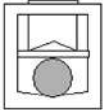
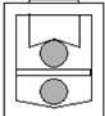
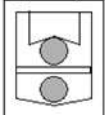
Reference Code	Type	Number of conductors	Cross-Section
TMP16	Rigid or flexible cable	1 or 2	1...4 mm ² 18...12 AWG
TMP25	Rigid or flexible cable	1 or 2	1...2.5 mm ² 2.5...6 mm ² 14...8 AWG ¹⁾
TMP65	Type	1 conductor connection in upper part only	Cross-Section
	Rigid cable		1...35 mm ²
	Cable without terminal		1.5...35 mm ²
	Cable with terminal		1...35 mm ²
	Flexible cable		1.5...35 mm ² 17...2 AWG
	Type	1 conductor connection in lower part only	Cross-Section
	Rigid cable		2.5...35mm ²
	Cable without terminal		6...35mm ²
	Cable with terminal		2.5...35mm ²
	Flexible cable		6...35mm ² 13...2 AWG
	Type	Connection of 2 conductors - Conductor in upper part	Cross-Section
	Rigid cable		1...35mm ²
	Cable without terminal		1.5...35mm ²
	Cable with terminal		1...35mm ²
	Flexible cable		1.5...35mm ² 17...2 AWG
	Type	Conductor in lower part	Cross-Section
	Rigid cable		2.5...35mm ²
	Cable without terminal		6...35mm ²
	Cable with terminal		2.5...35mm ²
	Flexible cable		6...35mm ² 13...2 AWG

Note: 1) 8 AWG for flexible cable only

Auxiliary Contact Block - TACB

Reference Code	TACBF-11			TACBS-11. TACBS-20. TACBS-02. TTSB			
For use with	TMP16 / TMP25 / TMP65						
Utilization Category	24 VAC	220-230 VAC		24 VAC	230 VAC	400 VAC	690 VAC
AC-15	2 A	0.5 A		6 A	6 A	3 A	1 A
AC-12	2.5 A		2.5 A	10 A	10 A	10 A	10 A
DC-13	24 VDC	48 VDC	60 VDC	24 VDC	110 VDC	220 VDC	440 VDC
	1 A	0.3 A	0.15 A	2 A	0.5 A	0.25 A	0.1 A
Type of terminal	Flat						
Type of screw	Philips (N°2)						
Tightening torque	0.8...1.2 N.m (7...10 lb.in)						
Rigid cable	1 or 2 x (0.5...1.5 mm ²)1 or 2 x (0.75...2.5 mm ²)2 x (18...14 AWG)						
Flexible cable							
Backup fuses gL/gG	10 A						

Undervoltage Release - TURMP

Reference Code	TURMP
For use with	TMP16 / TMP25 / TMP65
Operating voltage (Enables cir. breaker switch on)	0.85...1.1xU _s
Non-operating voltage (guarantees circuit breaker switch OFF)	0.7...0.35xU _s
Energization Consumption	20.2 VA / 13 W
Consumption	7.2 VA / 2.4 W
Max. opening time	20 ms
Type of terminal	Flat
Type of screws	Philips (N°2)
Tightening torque	0.8...1.2 N.m (7...10 lb.in)
Rigid cable	1 or 2 x (0.5...1.5 mm ²) . 1 or 2 x (0.75...2.5 mm) ² 2 x (18...14 AWG)
Flexible cable	
Back-up fuses gL/gG	10 A

Shunt Release - TSRMP

Reference Code	TSRMP
For use with	TMP16 / TMP25 / TMP65
Operating Voltage (guarantee circuit breaker switch OFF)	0.7...1.1xU _s
Consumption - Energization	20.2 VA / 13 W
Maximum opening time	20 ms
Type of terminal	Flat
Type of screw	Philips (N°2)
Tightening torque	0.8...1.2 N.m (7...10 lb.in)
Rigid cable	1 or 2 x (0.5...1.5 mm ²)1 or 2 x (0.75...2.5 mm) ² 2 x (18...14 AWG)
Flexible cable	
Back-up fuses gL/gG	10 A

Motor Protective Circuit Breakers TMP25 - Coordination Tables

Type "1" Coordination - Rated conditional short-circuit current $I_{k} = 50 \text{ kA}/400\text{-}415 \text{ V}$

Direct-on-line starters

Direct-on-line starters consist of a motor protective circuit breaker TMP25 and TCM contactor, which are already electrically and mechanically connected via the block module TECCMP

Rated operational power 400-415 V (kW)	Rated operational current I_b (A)	Setting overload release  I_{set} (A)	Reference Code Motor Protective Circuit Breaker	Reference Code Contactors Actuating Voltage (230V 50/60Hz)
0.06	0.21	0.16...0.25	TMP25-3-C025	TCM9-10-30D24(230V 50/60Hz)
0.09	0.31	0.25...0.4	TMP25-3-D004	TCM9-10-30D24(230V 50/60Hz)
0.12	0.41	0.4...0.63	TMP25-3-C063	TCM9-10-30D24(230V 50/60Hz)
0.18	0.6	0.4...0.63	TMP25-3-C063	TCM9-10-30D24(230V 50/60Hz)
0.25	0.8	0.63...1.0	TMP25-3-U001	TCM9-10-30D24(230V 50/60Hz)
0.37	1.1	1.0...1.6	TMP25-3-D016	TCM9-10-30D24(230V 50/60Hz)
0.55	1.5	1.0...1.6	TMP25-3-D016	TCM9-10-30D24(230V 50/60Hz)
0.75	1.9	1.6...2.5	TMP25-3-D025	TCM9-10-30D24(230V 50/60Hz)
1.1	2.6	2.5...4.0	TMP25-3-U004	TCM9-10-30D24(230V 50/60Hz)
1.5	3.6	2.5...4.0	TMP25-3-U004	TCM9-10-30D24(230V 50/60Hz)
2.2	5	4.0...6.3	TMP25-3-D063	TCM9-10-30D24(230V 50/60Hz)
3.0	6.6	6.3...10	TMP25-3-U010	TCM9-10-30D24(230V 50/60Hz)
4.0	8.5	6.3...10	TMP25-3-U010	TCM9-10-30D24(230V 50/60Hz)
5.5	11.3	10...16	TMP25-3-U016	TCM12-10-30D24(230V 50/60Hz)
7.5	15.2	10...16	TMP25-3-U016	TCM18-10-30D24(230V 50/60Hz)
9.2	17.8	16...20	TMP25-3-U020	TCM18-10-30D24(230V 50/60Hz)
11	21.7	20...25	TMP25-3-U025	TCM25-10-30D24(230V 50/60Hz)
15	29.3	25...32	TMP25-3-U032	TCM32-10-30D24(230V 50/60Hz)

Ordering example: The type can be found in the "Rated operation power" column alongside the selected rating 2,2kW, desired type: TMP25-3-D063 + TCM9-10-30D24(230V 50/60Hz).

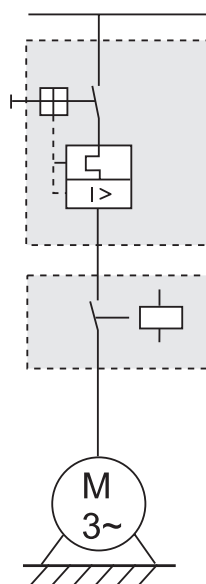

Motor Protective Circuit Breakers TMP25 - Coordination Tables

Type "2" Coordination - Rated conditional short-circuit current $I_q = 50/65kA$ in 400-415 V

Direct-on-line starters

Direct-on-line starters consists of a motor protective circuit breaker TMP25 and TCM contactor, which are already electrically and mechanically connected via the block module TECCMP up to 32A.

Rated operational power 400-415 V (kW)	Rated operational current I_b (A)	Setting overload release  I_r (A)	Reference Code Motor Protective Circuit Breaker	$I_q = 50kA$	$I_q = 65kA$
				Reference Code Contactors Actuating Voltage (230V 50/60Hz)	Reference Code Contactors Actuating Voltage (230V 50/60Hz)
0.06	0.21	0.16...0.25	TMP25-3-C025	TCM9-10-30D24(230V 50/60Hz)	TCM9-10-30D24(230V 50/60Hz)
0.09	0.31	0.25...0.4	TMP25-3-D004	TCM9-10-30D24(230V 50/60Hz)	TCM9-10-30D24(230V 50/60Hz)
0.12	0.41	0.4...0.63	TMP25-3-C063	TCM9-10-30D24(230V 50/60Hz)	TCM9-10-30D24(230V 50/60Hz)
0.18	0.6	0.4...0.63	TMP25-3-C063	TCM9-10-30D24(230V 50/60Hz)	TCM9-10-30D24(230V 50/60Hz)
0.25	0.8	0.63...1.0	TMP25-3-U001	TCM9-10-30D24(230V 50/60Hz)	TCM9-10-30D24(230V 50/60Hz)
0.37	1.1	1.0...1.6	TMP25-3-D016	TCM9-10-30D24(230V 50/60Hz)	TCM9-10-30D24(230V 50/60Hz)
0.55	1.5	1.0...1.6	TMP25-3-D016	TCM9-10-30D24(230V 50/60Hz)	TCM9-10-30D24(230V 50/60Hz)
0.75	1.9	1.6...2.5	TMP25-3-D025	TCM9-10-30D24(230V 50/60Hz)	TCM9-10-30D24(230V 50/60Hz)
1.1	2.6	2.5...4.0	TMP25-3-U004	TCM9-10-30D24(230V 50/60Hz)	TCM25-10-30D24(230V 50/60Hz)
1.5	3.6	2.5...4.0	TMP25-3-U004	TCM9-10-30D24(230V 50/60Hz)	TCM25-10-30D24(230V 50/60Hz)
2.2	5	4.0...6.3	TMP25-3-D063	TCM9-10-30D24(230V 50/60Hz)	TCM25-10-30D24(230V 50/60Hz)
3.0	6.6	6.3...10	TMP25-3-U010	TCM9-10-30D24(230V 50/60Hz)	TCM32-10-30D24(230V 50/60Hz)
4.0	8.5	6.3...10	TMP25-3-U010	TCM9-10-30D24(230V 50/60Hz)	TCM32-10-30D24(230V 50/60Hz)
5.5	11.3	10...16	TMP25-3-U016	TCM12-10-30D24(230V 50/60Hz)	TCM32-10-30D24(230V 50/60Hz)
7.5	15.2	10...16	TMP25-3-U016	TCM18-10-30D24(230V 50/60Hz)	TCM32-10-30D24(230V 50/60Hz)
9.2	17.8	16...20	TMP25-3-U020	TCM18-10-30D24(230V 50/60Hz)	TCM32-10-30D24(230V 50/60Hz)
11	21.7	20...25	TMP25-3-U025	TCM25-10-30D24(230V 50/60Hz)	TCM40-10-30D24(230V 50/60Hz)
15	29.3	25...32	TMP25-3-U032	TCM50-10-30D24(230V 50/60Hz)	TCM50-10-30D24(230V 50/60Hz)

Ordering example: The type can be found in the "Rated operation power" column alongside the selected rating 2,2kW, desired type: TMP25-3-D063 + TCM9-10-30D24(230V 50/60Hz).

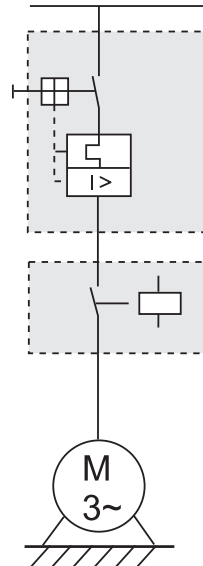

TEKNIC

Motor Protective Circuit Breakers TMP - Rated Short-Circuit Breaking Capacity (IEC 60947-2)

TMP16 / TMP25 / TMP65

Reference Code	Setting Overload Release (A)	220-230VAC			380-415VAC			440VAC			460-500VAC			630-690VAC		
		I _{cu}	I _{cs}	Max. Fuse (gL/gG)	I _{cu}	I _{cs}	Max. Fuse (gL/gG) ¹⁾	I _{cu}	I _{cs}	Max. Fuse (gL/gG) ¹⁾	I _{cu}	I _{cs}	Max. Fuse (gL/gG) ¹⁾	I _{cu}	I _{cs}	Max. Fuse (gL/gG) ¹⁾
		kA	kA	A	kA	kA	A	kA	kA	A	kA	kA	A	kA	kA	A
TMP16	0.10...0.16	100	100	-	100	100	-	100	100	-	100	100	-	10	10	-
	0.16...0.25	100	100	-	100	100	-	100	100	-	100	100	-	10	10	-
	0.25...0.4	100	100	-	100	100	-	100	100	-	100	100	-	10	10	-
	0.4...0.63	100	100	-	100	100	-	100	100	-	100	100	-	10	10	-
	0.63...1	100	100	-	100	100	-	100	100	-	100	100	-	10	10	-
	1...1.6	100	100	-	100	100	-	100	100	-	100	100	-	10	10	-
	1.6...2.5	100	100	-	100	100	-	100	100	-	100	100	-	8	8	25
	2.5...4	100	100	-	100	100	-	100	100	-	100	100	-	8	8	35
	4...6.3	100	100	-	100	100	-	100	100	-	100	100	-	8	8	50
6.3...10	100	100	-	50	10	100	50	10	80	10	10	63	5	5	50	
10...16	100	100	-	10	10	100	10	10	80	10	10	80	4	3	63	
TMP25	0.10...0.16	100	100	-	100	100	-	100	100	-	100	100	-	100	100	-
	0.16...0.25	100	100	-	100	100	-	100	100	-	100	100	-	100	100	-
	0.25...0.4	100	100	-	100	100	-	100	100	-	100	100	-	100	100	-
	0.4...0.63	100	100	-	100	100	-	100	100	-	100	100	-	100	100	-
	0.63...1	100	100	-	100	100	-	100	100	-	100	100	-	100	100	-
	1...1.6	100	100	-	100	100	-	100	100	-	100	100	-	100	100	-
	1.6...2.5	100	100	-	100	100	-	100	100	-	100	100	-	8	8	25
	2.5...4	100	100	-	100	100	-	100	100	-	100	100	-	8	8	32
	4...6.3	100	100	-	100	100	-	100	100	-	100	100	-	8	8	50
	6.3...10	100	100	-	100	100	-	50	25	80	42	21	63	8	8	50
	10...16	100	100	-	50	25	100	50	15	80	10	8	80	5	5	63
	16...20	100	100	-	50	25	125	50	15	80	10	8	80	5	5	63
	20...25	100	100	-	50	25	125	50	15	100	10	8	80	5	5	63
25...32	100	100	-	50	25	125	25	15	100	10	8	80	5	5	63	
TMP65	10...16	100	100	-	50	50	100	50	50	80	15	15	80	8	8	63
	16...20	100	100	-	50	50	125	50	50	80	15	15	80	8	8	63
	20...25	100	100	-	50	50	125	50	50	100	15	15	80	8	8	63
	25...32	100	100	-	50	50	125	50	50	100	15	15	80	5	5	63
	32...40	100	100	-	50	50	160	50	50	125	15	10	100	5	5	63
	40...50	100	100	-	50	50	160	50	50	125	15	10	100	5	5	80
	50...65	100	100	-	50	50	160	50	50	125	15	10	100	5	5	80

Self protected against short-circuits up to 100kA

Back-up fuse not required

- Fuse amounts required for greater short-circuit currents.
UL values on request

Motor Protective Circuit Breakers TMP - Characteristics Curves

The tripping characteristic shows the motor circuit breaker trip time in relation to the rated current.

The curves show average tolerance range values for an ambient temperature of 20°C, starting in cold state. Thermal trip time when working in operating temperature is reduced to around 25% of the presented values. Under normal operating conditions, all 3 circuit breaker phases must be conducting.

TMP16/25/65

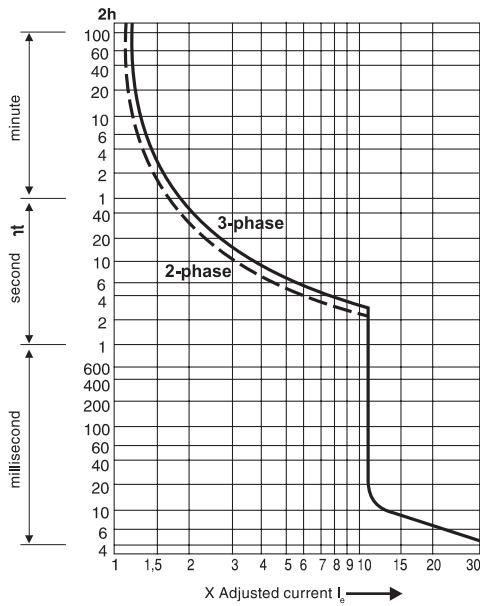

Characteristic I²t at 415V - TMP16

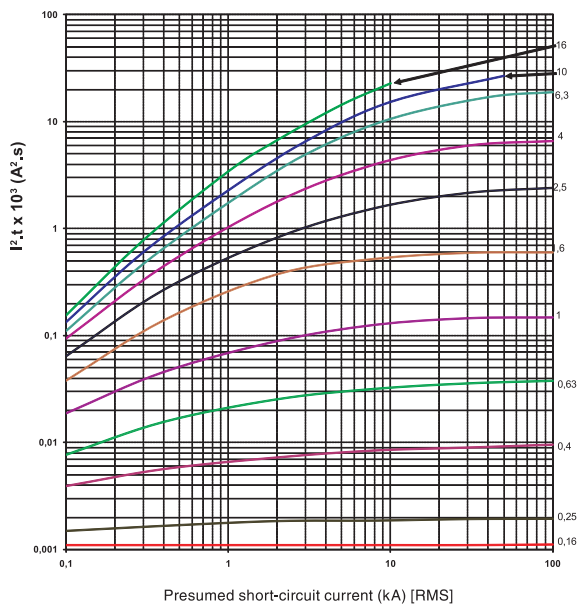

Characteristic I²t at 415V - TMP25

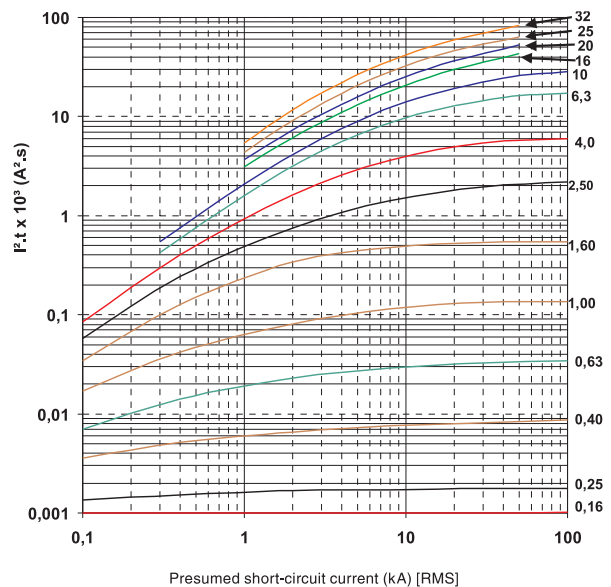

Note: 1) Other characteristic curves on request

Motor Protective Circuit Breakers TMP - Rated Short-Circuit Breaking Capacity (IEC 60947-2) - Limiter Function

TMP25 + CLT25

Reference Code	Setting Overload Release (A)	380-415VAC			440VAC			460-500VAC			630-690VAC		
		I_{cu}	I_{cs}	Max. Fuse (gL/gG)	I_{cu}	I_{cs}	Max. Fuse (gL/gG)	I_{cu}	I_{cs}	Max. Fuse (gL/gG)	I_{cu}	I_{cs}	Max. Fuse (gL/gG)
		kA	kA	A	kA	kA	A	kA	kA	A	kA	kA	A
TMP25 + CLT25	0.10...0.16	♦	♦	-	♦	♦	-	♦	♦	-	♦	♦	-
	0.16...0.25	♦	♦	-	♦	♦	-	♦	♦	-	♦	♦	-
	0.25...0.4	♦	♦	-	♦	♦	-	♦	♦	-	♦	♦	-
	0.4...0.63	♦	♦	-	♦	♦	-	♦	♦	-	♦	♦	-
	0.63...1	♦	♦	-	♦	♦	-	♦	♦	-	♦	♦	-
	1...1.6	♦	♦	-	♦	♦	-	♦	♦	-	♦	♦	-
	1.6...2.5	♦	♦	-	♦	♦	-	♦	♦	-	50	50	-
	2.5...4	♦	♦	-	♦	♦	-	♦	♦	-	50	50	-
	4...6.3	♦	♦	-	♦	♦	-	♦	♦	-	50	50	-
	6.3...10	♦	♦	-	100	100	-	100	100	-	50	50	-
	10...16	100	100	-	100	100	-	100	100	-	50	50	-
	16...20	100	100	-	100	100	-	100	100	-	50	50	-
20...25	100	100	-	100	100	-	100	100	-	10	10	-	
25...32	100	100	-	100	100	-	100	100	-	10	10	-	

TMP65

Reference Code	Setting Overload Release (A)	380-415VAC			440VAC			460-500VAC			630-690VAC		
		I_{cu}	I_{cs}	Max. Fuse (gG/gL)	I_{cu}	I_{cs}	Max. Fuse (gG/gL)	I_{cu}	I_{cs}	Max. Fuse (gG/gL)	I_{cu}	I_{cs}	Max. Fuse (gG/gL)
		kA	kA	A	kA	kA	A	kA	kA	A	kA	kA	A
TMP65 + TMP65i-3-U065	10...16	65	65	-	65	65	-	65	65	-	25	25	-
	16...20	65	65	-	65	65	-	65	65	-	25	25	-
	20...25	65	65	-	65	65	-	65	65	-	25	25	-
	25...32	65	65	-	65	65	-	65	65	-	25	25	-
	32...40	65	65	-	65	65	-	65	65	-	25	25	-
	40...50	65	65	-	65	65	-	65	65	-	25	25	-
	50...65	65	65	-	65	65	-	65	65	-	25	25	-

Self protected against short-circuits up to 100kA

Back-up fuse not required

- 1) Fuse amounts required for higher short-circuit currents.

Not applicable due to TMP25/TMP65 already having 100 kA of I_{cu} / I_{cs} in referred ranges.

Motor Protective Circuit Breakers TMP - Tripping Characteristic Curves

Characteristic I^2t at 415V - TMP65

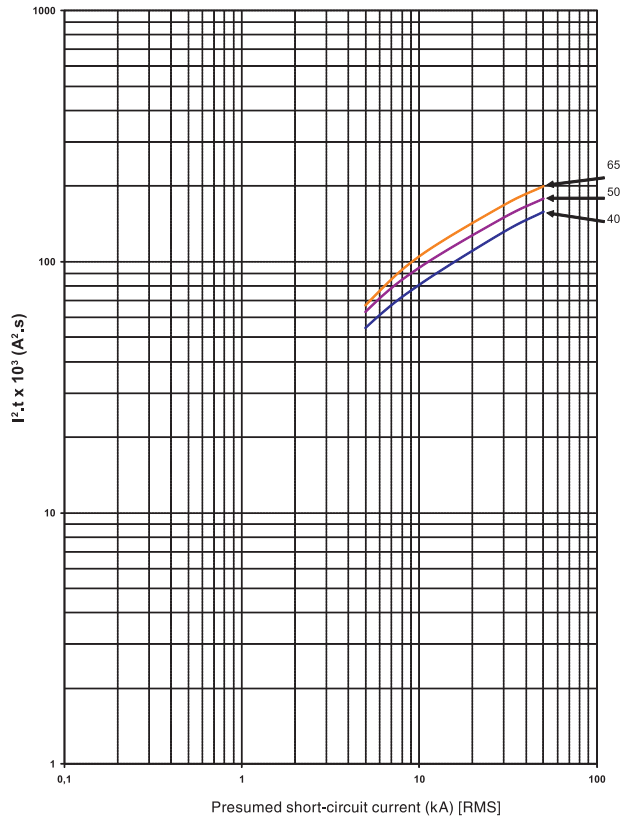

Notes: 1) Thermal Tripping current: Curve presented for an ambient temperature of 20°C starting from cold state.
 2) Magnetic Tripping Current: Corresponds to 13 times the maximum adjustment range value.

TEKNIC

Connection Diagrams and Typical Circuits

Connection Diagrams

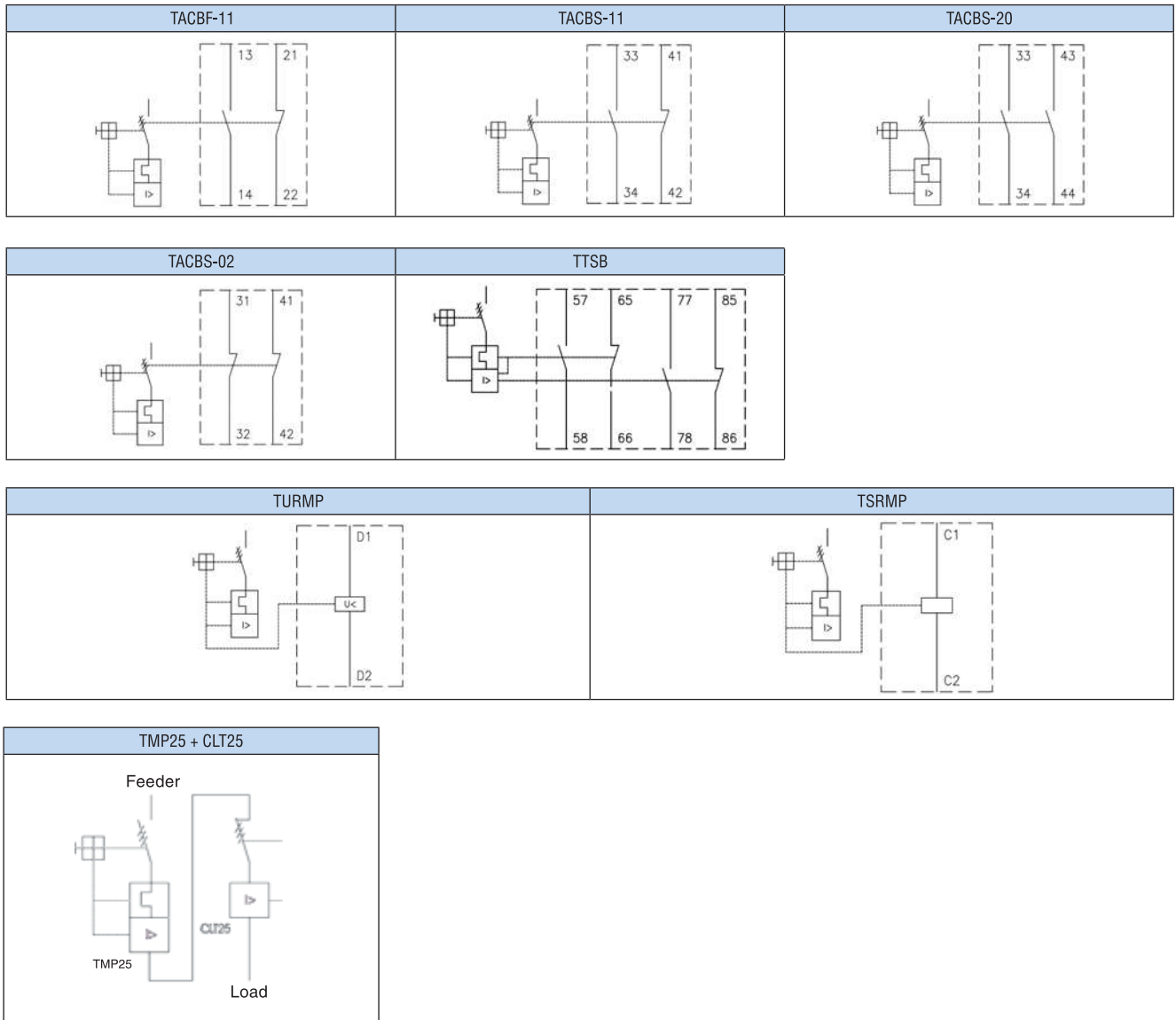

Typical Circuits

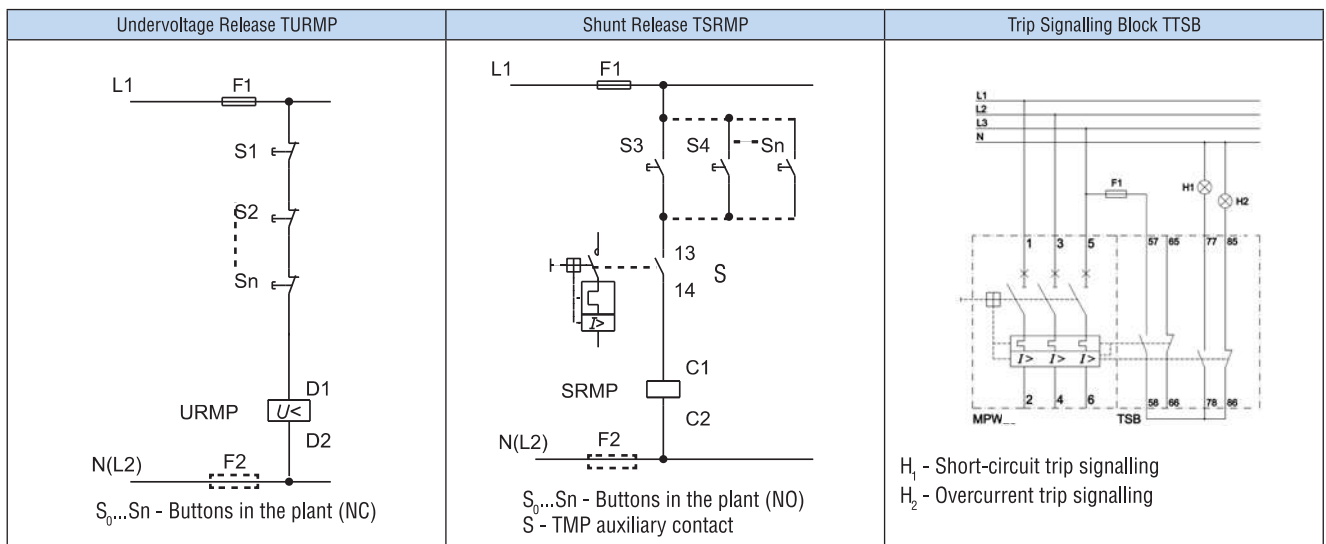

TEKNIC

Motor Protective Circuit Breakers TMP - Dimensions (mm)

TMP16 + Accessories

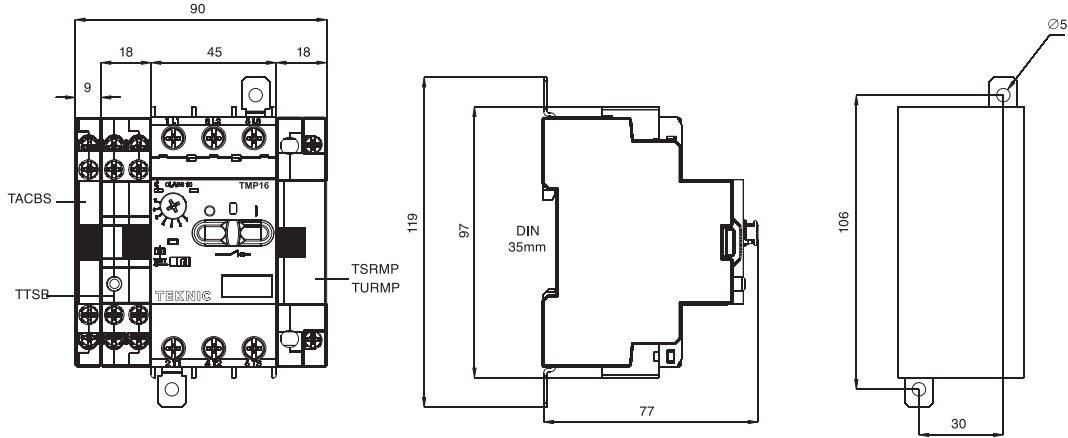

Mounting Position

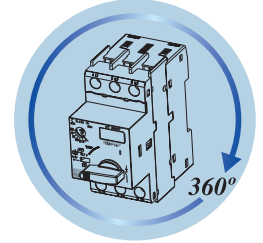

TMP16 +TCC07...16

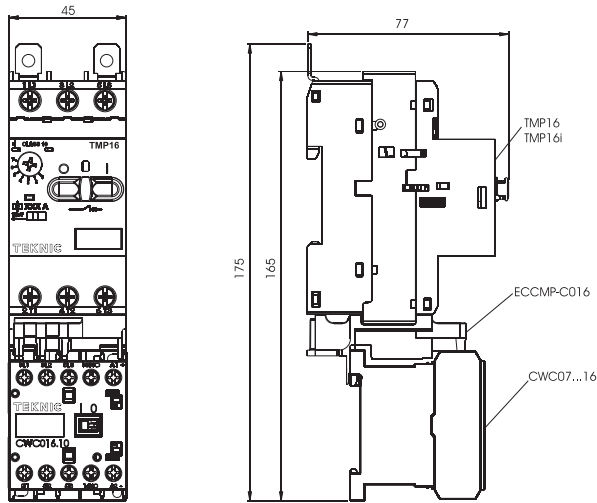

Insulated Enclosure - MPE66 (IP66)

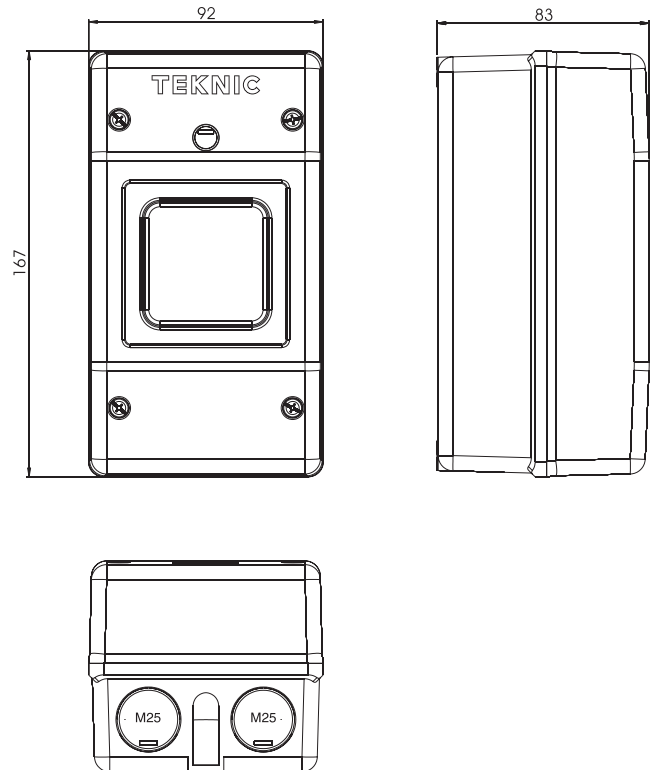

TEKNIC

Motor Protective Circuit Breakers TMP - Dimensions (mm)

TMP25 + Accessories

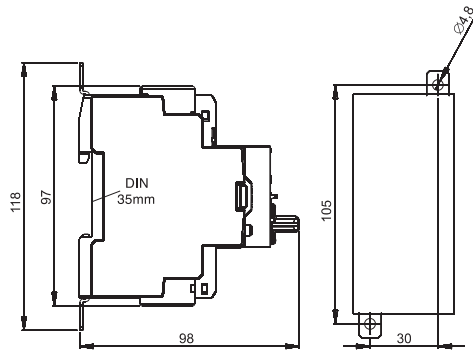
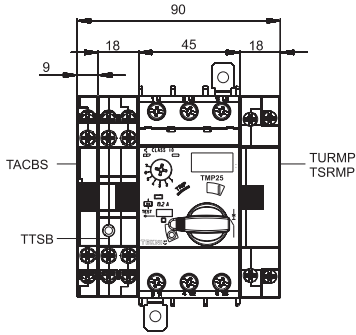

Mounting Position

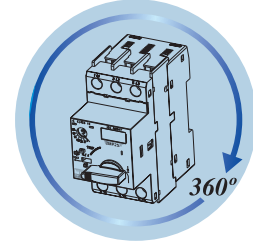

TMP25 +TCC07...16

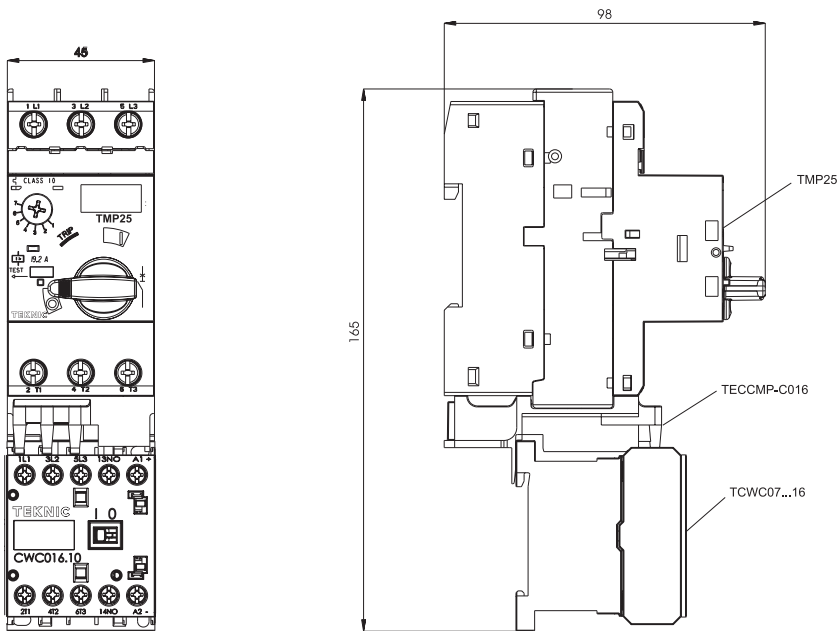

Motor Protective Circuit Breakers TMP - Dimensions (mm)

TMP25 + TCC025

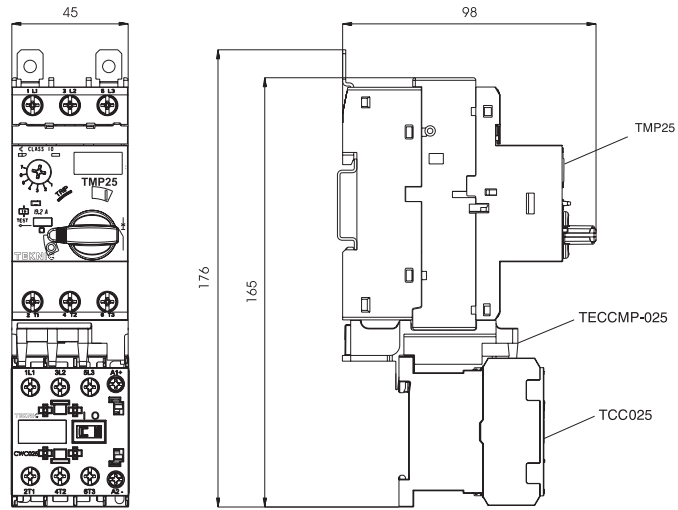

TMP25 + TCM9...18

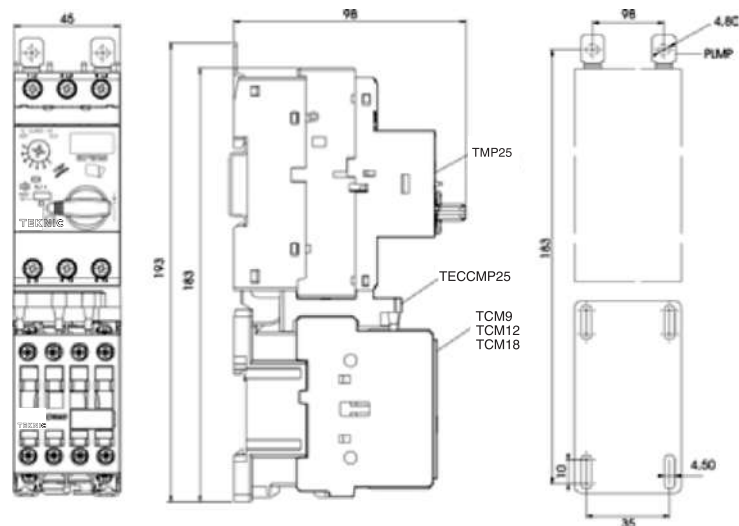

TMP25 + TCM25

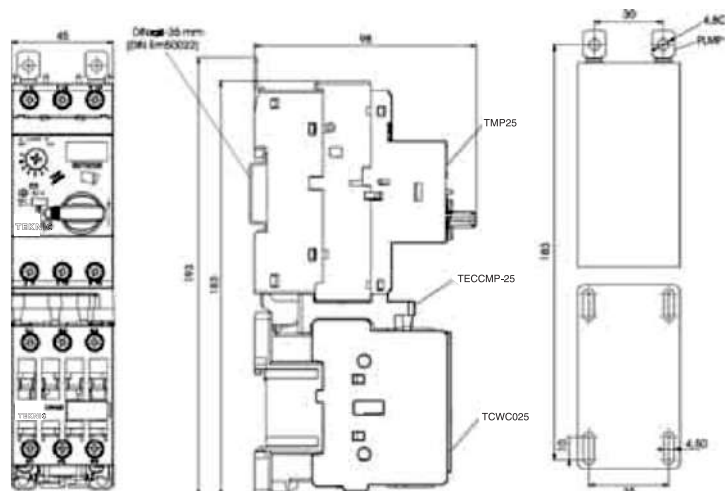

Motor Protective Circuit Breakers TMP - Dimensions (mm)

TMP25 + TCM32

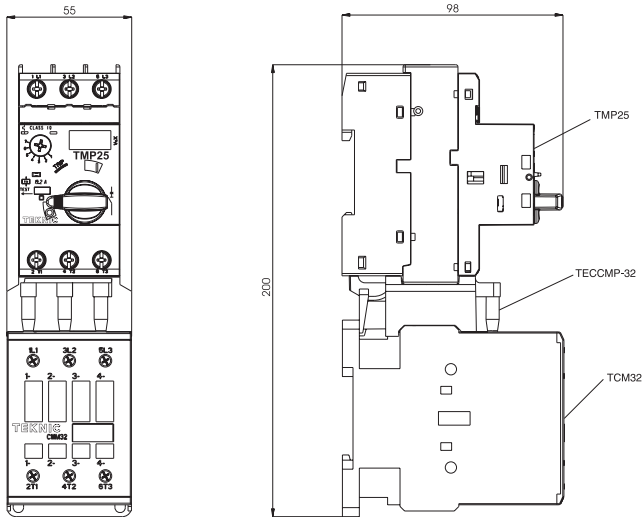

Current limiter - CLT25

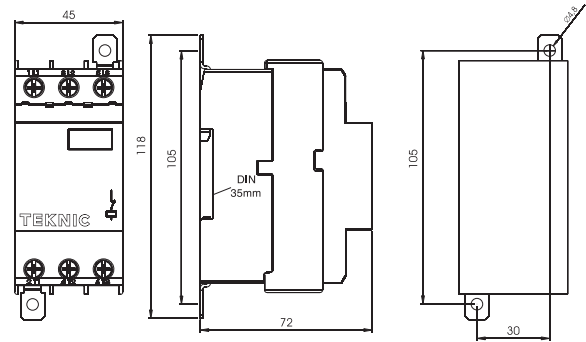

Insulated Enclosure - MPE55 (IP55)



Motor Protective Circuit Breakers TMP - Dimensions (mm)

Door Coupling Rotary Handle - TMRX

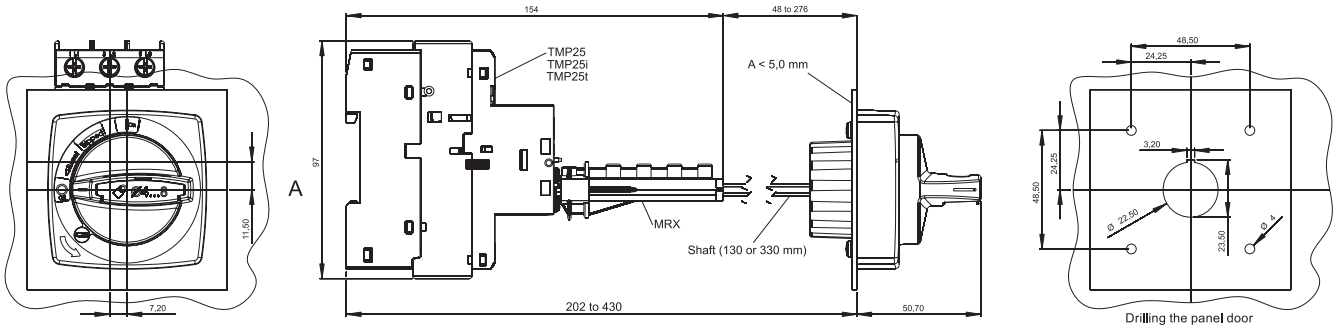

TMP65 + Accessories

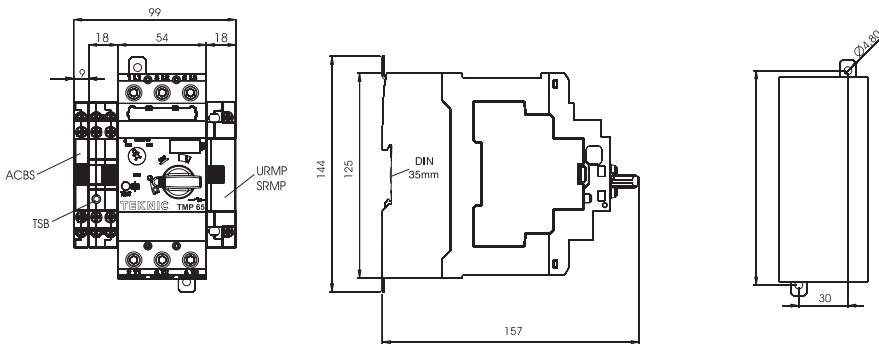

Mounting Position

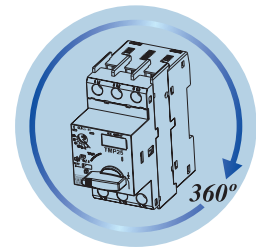

Door Coupling Rotary Handle - TMR65

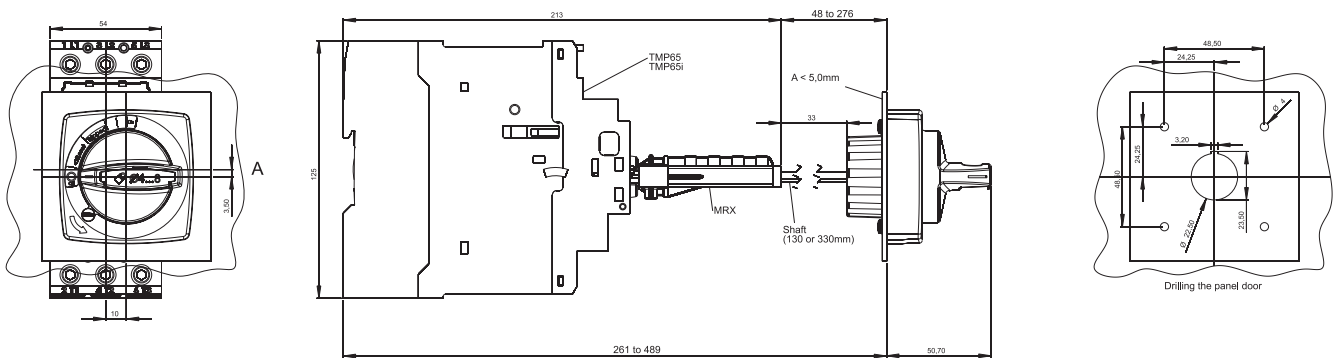

Product-System Motor-Protective Circuit Breaker MS

Overview

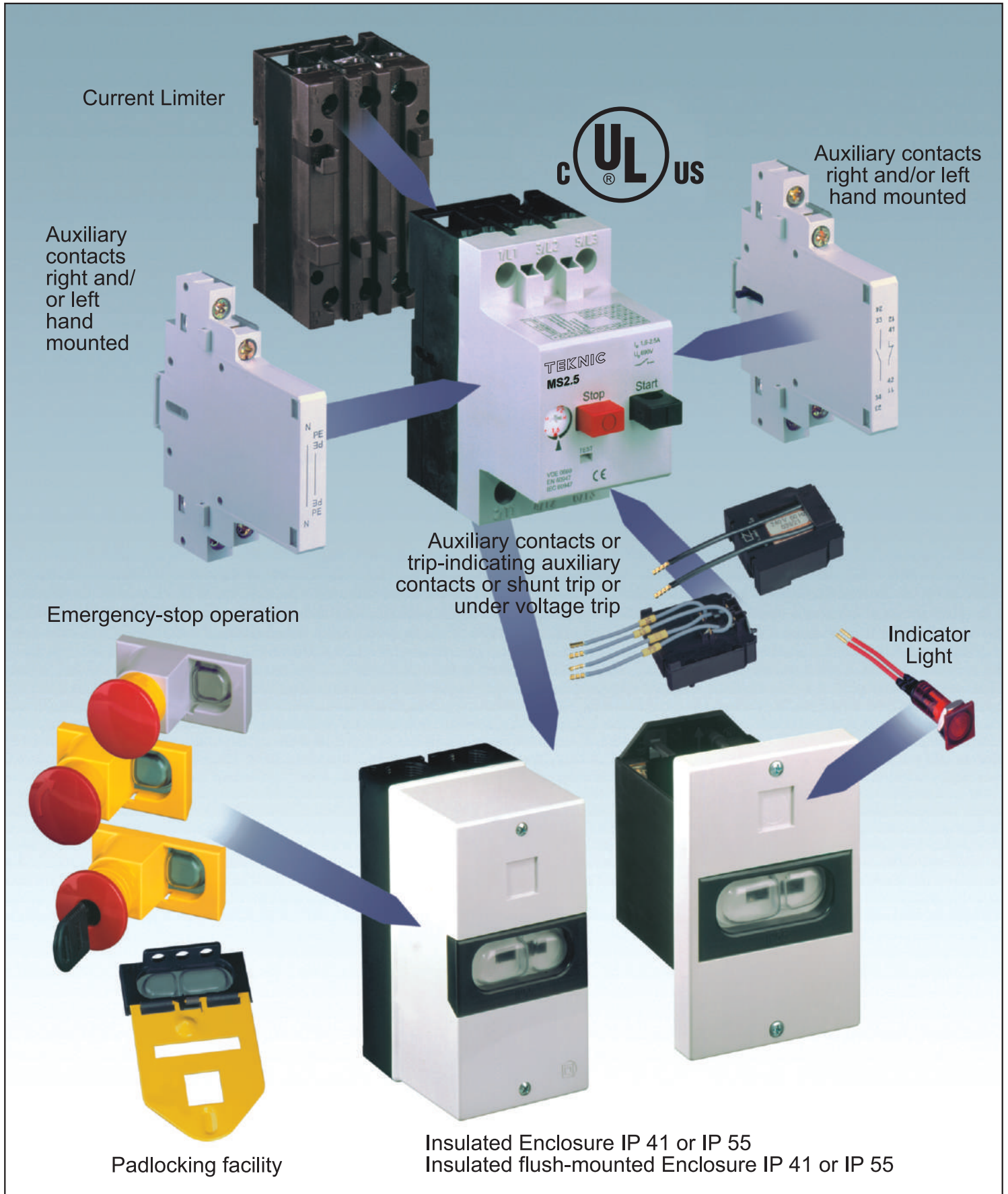

Motor-Protective Circuit Breaker MS

with overload and short circuit releases, phase failure sensitivity according to IEC 947-4-1, DIN VDE 0660 Part 102

Due to its high breaking capacity with high current limitation the Motor Protective Circuit Breakers MS provide an optimum of protection for electrical motors as well as for other consumer units up to 25 amps.

They are equipped with phase failure sensitivity, isolating and main switch functions; 13 ranges are covering nominal rated currents from 0.1 up to 25 amps.

The MPCBs are self protected up to 6,3 amps at 400 volts. Ranges > 6,3 amps provide a breaking capacity of 6 kA. The MPCBs are temperature compensated; the actuating current of the short circuit release is $12 \times I_n$.

The Motor Protective Circuit Breakers are in accordance with IEC 947 and fulfill 

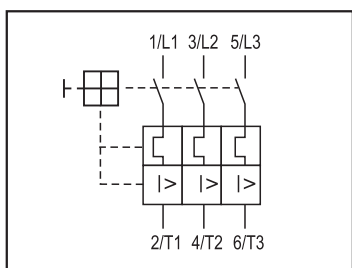

max. rated operational power (kW/AC 3)				overload release adjustment (A)	Instantaneous setting (A)	Article No.	Weight g/pcs.	Packing units
400 V	440 V	500 V	690 V					
-	-	-	0,06	0,1 - 0,16	1,92	MS016	250	1
0,06	0,06	0,06	0,12	0,16 - 0,25	3	MS025	250	1
0,09	0,12	0,12	0,18	0,25 - 0,4	4,8	MS04	250	1
0,12	0,18	0,25	0,25	0,4 - 0,63	7,6	MS063	250	1
0,25	0,25	0,37	0,55	0,63 - 1	12	MS1	250	1
0,55	0,55	0,75	1,1	1 - 1,6	19,2	MS1.6	250	1
0,75	1,1	1,1	1,5	1,6 - 2,5	30	MS2.5	250	1
1,5	1,5	2,2	3	2,5 - 4	48	MS4	250	1
2,2	3	3	4	4 - 6,3	75,6	MS6.3	250	1
4	4	4	7,5	6,3 - 10	120	MS10	250	1
7,5	9	9	12,5	10 - 16	192	MS16	250	1
9	11	12,5	15	16 - 20	240	MS20	250	1
12,5	12,5	15	22	20 - 25	300	MS25	250	1

Current Limiter SBMS

increasing the breaking capacity up to 50 kA at 400 volts above the self protected area

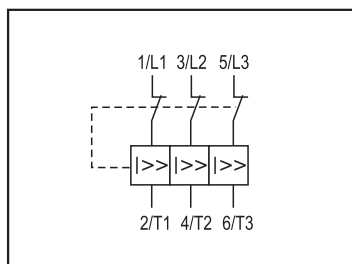

Nominal rated current (A)	Article No.	Weight g/pc.	Packing unit
32	SBMS32	175	1

Motor-Protective Switch (thermal only) BS

phase failure sensitivity according IEC 947-4-1, DIN VDE 0660 Part 102



1/L1 3/L2 5/L3

2/T1 4/T2 6/T3

max. rated operational power (kW/AC 3) 440 V 415 V	max. rated operational power (kW/AC 3)			overload release adjustment (A)	Article No.	Weight g/pcs.	Packing units
	440 V	500 V	690 V				
0,12	0,18	0,25	0,25	0,4 - 0,63	BS063	230	1
0,25	0,25	0,37	0,55	0,63 - 1	BS1	230	1
0,55	0,55	0,75	1,1	1 - 1,6	BS1.6	230	1
0,75	1,1	1,1	1,5	1,6 - 2,5	BS2.5	230	1
1,5	1,5	2,2	3	2,5 - 4	BS4	230	1
2,2	3	3	4	4 - 6,3	BS6.3	230	1
4	4	4	7,5	6,3 - 10	BS10	230	1
7,5	9	9	12,5	10 - 16	BS16	230	1
9	11	12,5	15	16 - 20	BS20	230	1
12,5	12,5	15	22	20 - 25	BS25	230	1

Circuit Breaker (magnetic only) KS

with short circuit releases



1/L1 3/L2 5/L3

> > >

2/T1 4/T2 6/T3

Nominal rated current (A)	Article No.	Weight g/pcs.	Packing units
16	KS16	250	1
20	KS20	250	1
25	KS25	250	1

Motor-Protective Circuit Breaker MSH for single phase motors

with overload and short circuit releases according IEC 947-4-1, DIN VDE 0660 Part 102
with integrated auxiliary contact 1NO



max. AC 3 rating (kW) 400 V	overload release adjustment (A)	Instantaneous setting (A)	Article No.	Weight g/pcs.	Packing units
0,06	0,63 - 1	12	MSH1	290	1
0,12	1 - 1,6	19,2	MSH1.6	290	1
0,25	1,6 - 2,5	30	MSH2.5	290	1
0,37	2,5 - 4	48	MSH4	290	1
0,75	4 - 6,3	75,6	MSH6.3	290	1
1,1	6,3 - 10	120	MSH10	290	1
2,2	10 - 16	192	MSH16	290	1
3	16 - 20	240	MSH20	290	1

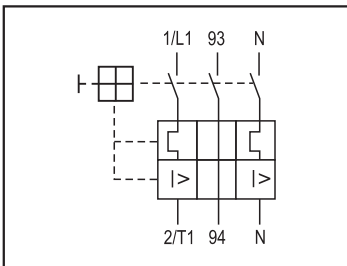

Motor-Protective Circuit Breaker MSW for single phase motors

with overload and short circuit releases according IEC 947-4-1, DIN VDE 0660 Part 102
without integrated auxiliary contact



max. AC 3 rating (kW) 400 V	overload release adjustment (A)	Instantaneous setting (A)	Article No.	Weight g/pcs.	Packing units
0,06	0,63 - 1	12	MSW1	210	1
0,12	1 - 1,6	19,2	MSW1.6	210	1
0,25	1,6 - 2,5	30	MSW2.5	210	1
0,37	2,5 - 4	48	MSW4	210	1
0,75	4 - 6,3	75,6	MSW6.3	210	1
1,1	6,3 - 10	120	MSW10	210	1
2,2	10 - 16	192	MSW16	210	1
3	16 - 20	240	MSW20	210	1

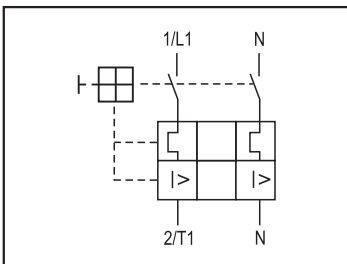

Protective Switch, (control) transformer protection, MST

with overload and short circuit releases, protecting (control) transformers with high inrush currents, actuating current of short circuit release 20 x I_n

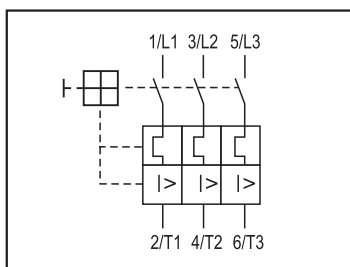

max. rated operational power (kVA)				overload release adjustment (A)	Instantaneous setting (A)	Article No.	Weight g/pcs.	Packing units
400 V	440 V	500 V	690 V					
-	-	-	-	0,1 - 0,16	3,2	MST016	250	1
-	-	0,16	-	0,16 - 0,25	5	MST025	250	1
0,16	-	0,25	0,25	0,25 - 0,4	8	MST040	250	1
0,25	-	0,4	0,4	0,4 - 0,63	12,6	MST063	250	1
0,4	0,63	0,63	1	0,63 - 1	20	MST1	250	1
0,63	1	1	-	1 - 1,6	32	MST1.6	250	1
1	1,6	1,6	2	1,6 - 2,5	50	MST2.5	250	1
1,6/1	2	2,5	2,5	2,5 - 4	80	MST4	250	1
2,5	4	4	6,3	4 - 6,3	126	MST6.3	250	1
4,0/5,0	5	6,3	-	6,3 - 10	200	MST10	250	1
6,3/8	10	10	10	10 - 16	320	MST16	250	1
12,5	12,5	16	-	16 - 20	400	MST20	250	1
12,5	16	16	-	20 - 25	500	MST25	250	1

Accessories

Auxiliary contact blocks for side mounting

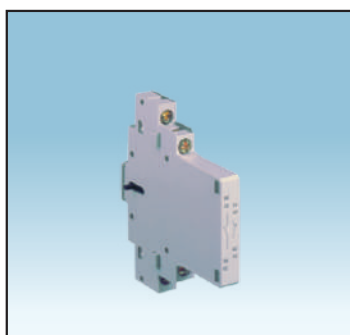

Width mm	Wiring diagram	Contacts	Article No.	Weight	Packing unit
9		2NO	HMS20	40	10
9		1NO + 1NC	HMS11	40	10
9		1NO	HMS10	35	10
9		2NC	HMS02	40	10
9		1NC	HMS01	35	10

Early make auxiliary contact blocks for side mounting

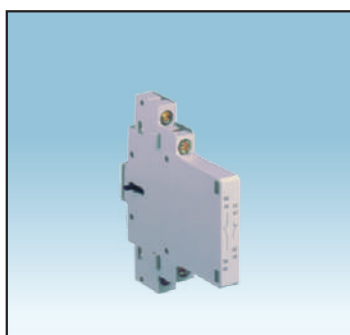

Width mm	Wiring diagram	Contacts	Article No.	Weight	Packing unit
9		1NO + 1NC	VHMS11	40	10
9		2NO	VHMS20	40	10

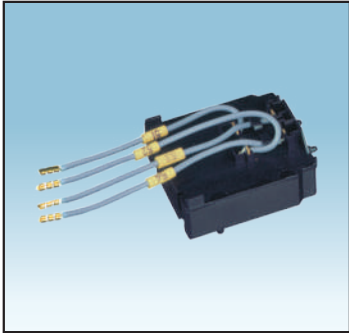

Auxiliary contact blocks for inside mounting

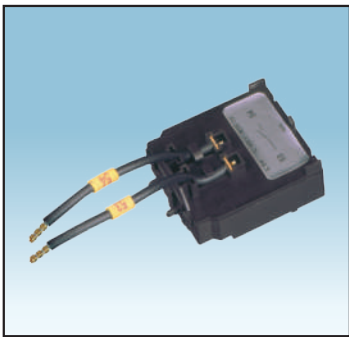

	Wiring diagram	Contacts	Article No.	Weight	Packing unit
		1NO + 1NC	EHMS11	25	10

Trip-indicating auxiliary contact blocks for inside mounting



	Wiring diagram	Contacts	Article No.	Weight	Packing unit
		1NO	SHMS10	25	10
		1NC	SHMSO1	25	10

It is possible to equip the Breakers with different auxiliary contacts. Aux. contacts HMS and EHMS operate in accordance with the main contacts. They are designed for remote signaling, electrical interlocking and control applications. Early make contacts VHMS operate earlier than the main contacts. Trip-indicating contacts operate in case of a fault.

Technical Data HMS, VHMS, EHMS, SHMS:

Rated impulse withstand voltage U_{imp}	4000 V
Rated operational voltage U_e	500 V
Utilisation category/Pollution level	III/3
Max. current (with free air circulation) I_{th}	6,0 A
Rated operational current I_e , AC- 15 duty, 230V / 400 V	3,5/2 A
Can also be used for low voltage and PLC-inputs	General data 24 V, 10 mA, according DIN 19240
Cable cross section:	
1 conductor (solid or stranded cable)	0,75 - 2,5 single wire, 0,75 - 1,5 fine wire
2 conductor (solid or stranded cable)	0,75 - 2,5 single wire, 0,75 - 1,5 fine wire

Shunt release to build in under the cover with wiring (140 mm)

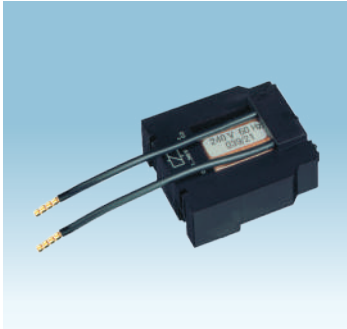

Rated operational voltage (V)	Article No.	Weight g/pc.	Packing unit
110 V 50 Hz, 120 V 60 Hz	AMS110	75	1
220-230V 50 Hz, 240 V 60 Hz	AMS220	75	1
380-415 V 50 Hz, 440 V 60 Hz	AMS380	75	1
24 V 50/60 Hz	AMS24	75	1
500 V 50 Hz	AMS500	75	1
24 V DC	AMSD24	75	1
Pick up $0,7 \times U_e$		100 % DF	1

D1

U <

D2

Under voltage releases to build in under the cover with wiring (140 mm)

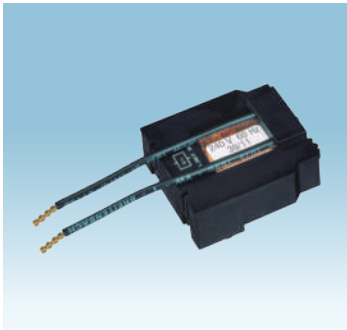

Rated operational voltage (V)	Article No.	Weight g/pc.	Packing unit
110 V 50 Hz, 120 V 60 Hz	UMS110	75	1
220-230V 50 Hz, 240 V 60 Hz	UMS220	75	1
380-415 V 50 Hz, 440 V 60 Hz	UMS380	75	1
24 V 50/60 Hz	UMS24	75	1
500 V 50 Hz	UMS500	75	1
Pick up $0,85 \times U_e$ Drop out $0,35... 0,7 \times U_e$		100 % DF	

C1

C2

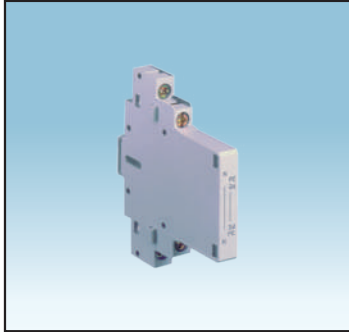

PE(N) Terminal Block
for side mounting
throughout PE- and N-conductor

Nom. rated current	Article No.	Weight g/pc.	Packing unit
6 A	NMS	35	10

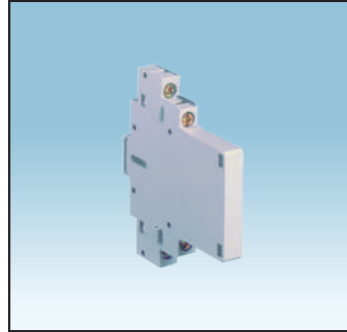

Terminal Block
for side mounting
with 2 terminals 0,75 to 2,5 mm²

Nom. rated current	Article No.	Weight g/pc.	Packing unit
6 A	KSMS2	40	10



Insulated enclosure IP 41
with integrated PE(N) terminal
top and bottom each 2 metric
knock-outs

Article No.	Weight g/pc.	Packing unit
MS.G41	220	1

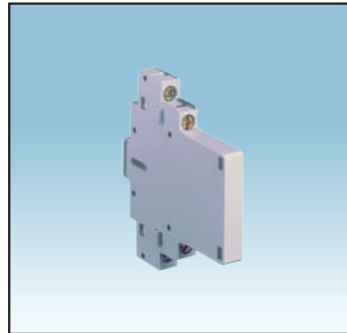

Terminal Block
for side mounting
with 4 terminals 0,75 to 2,5 mm²

Article No.	Weight g/pc.	Packing unit
KSMS4	45	10



Insulated enclosure IP 55
with integrated PE(N) terminal
top and bottom each 2 metric
knock-outs

Article No.	Weight g/pc.	Packing unit
MS.G55	240	1

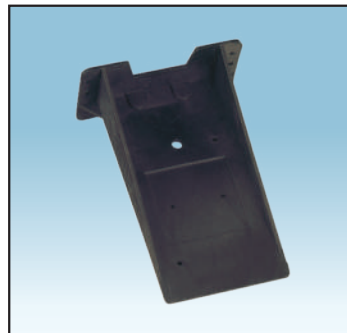

Mounting angle
for sub-table mounting

Article No.	Weight g/pc.	Packing unit
MS.A	99	1



Insulated enclosure IP 41
with integrated PE(N) terminal

Article No.	Weight g/pc.	Packing unit
MS.F41	150	1



Insulated enclosure with CEE-plug IP 54
16 A, 5-pole, 3P + N + PE
1 opening at the bottom

Article No.	Weight g/pc.	Packing unit
MS.C51	420	1



Flush mounting enclosure IP 55
with integrated PE(N) terminal

Article No.	Weight g/pc.	Packing unit
MS.F55	170	1



Insulated enclosure with CEE-plug IP 54 and phase inverter
16 A, 5-pole, 3P + N + PE,
1 opening at the bottom

Article No.	Weight g/pc.	Packing unit
MS.P51	420	1

TEKNIC

Accessories

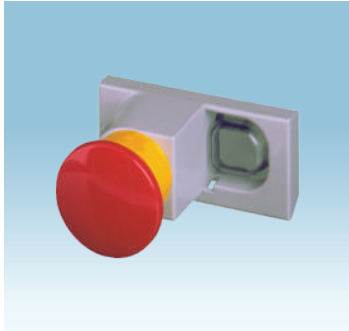

Mushroom button
spring release
red on grey background

Article No.	Weight g/pc.	Packing unit
MS.PT	55	5



Padlocking facility
for up to three padlocks

Article No.	Weight g/pc.	Packing unit
MS.VS	100	10

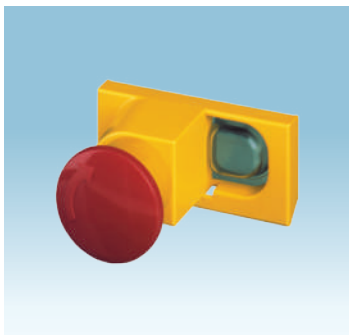

Emergency-stop operations
stay-put, twist to release
red on yellow background

Article No.	Weight g/pc.	Packing unit
MS.PV	60	5

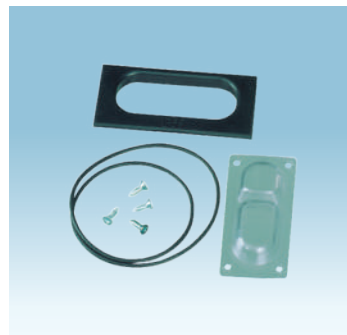

Kit for IP 55
to increase degree of protection
from IP 41 to IP 55

Article No.	Weight g/pc.	Packing unit
MS.BS	25	10



Emergency-stop operation
stay-put, key release
red on yellow background

Article No.	Weight g/pc.	Packing unit
MS.PS2	65	5

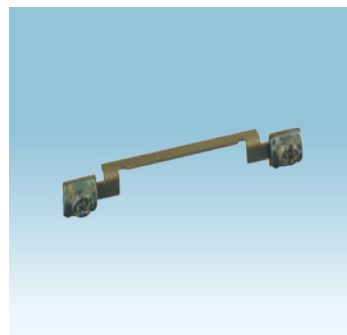

N-Terminal
connecting on fifth conductor

Article No.	Weight g/pc.	Packing unit
MS.N	10	10



Indicator light
with neon bulb,
nominal rated voltage: 220 - 240 V

Colour	Article No.	Weight g/pc.	Packing unit
transp.	MS.SLW2	10	5
green	MS.SLG2	10	5
red	MS.SLR2	10	5
yellow	MS.SLJ2	10	5



Indicator light
with neon bulb,
nominal rated voltage: 380 - 440 V

Colour	Article No.	Weight g/pc.	Packing unit
transp.	MS.SLW3	10	5
green	MS.SLG3	10	5
red	MS.SLR3	10	5
yellow	MS.SLJ3	10	5

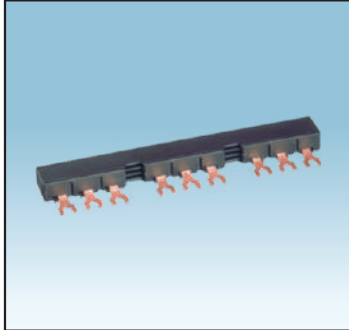

Three-phase common links

Description	Rated continuous current (A)	length	Article No.	Weight g/pc.	Packing unit
for 2 MPCBs without auxiliary contact units	63	90 mm	SB.D02	37	10
for 3 MPCBs without auxiliary contact units	63	136 mm	SB.D03	55	10
for 4 MPCBs without auxiliary contact units	63	180 mm	SB.D04	75	10
for 2 MPCBs each with 1 auxiliary contact unit fitted on the right side	63	99 mm	SB.D12	40	10
for 3 MPCBs each with 1 auxiliary contact unit fitted on the right side	63	153 mm	SB.D13	65	10
for 4 MPCBs each with 1 auxiliary contact unit fitted on the right side	63	207 mm	SB.D14	90	10
for 5 MPCBs each with 1 auxiliary contact unit fitted on the right side	63	261 mm	SB.D15	115	10
for 2 MPCBs each with 2 auxiliary contact units fitted on the right and left side	63	108 mm	SB.D22	45	10
for 4 MPCBs each with 2 auxiliary contact units fitted on the right and left side	63	234 mm	SB.D24	105	10

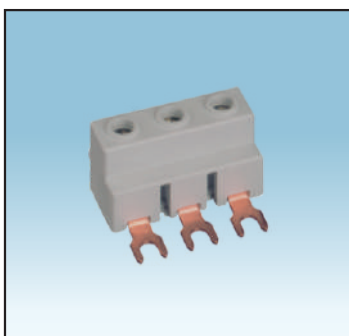

Incoming terminal block

	Rated continuous current (A)		Article No.	Weight g/pc.	Packing unit
	63		SB.DE1	30	10



Shroud

			Article No.	Weight g/pc.	Packing unit
for unused terminals			SB.DA1	5	10

Back-up-protection (if short circuit current higher than breaking capacity of MS)				
overload release adjustment	Back-up fuse (gL, aM) (A)			
	230 V	400 V	500 V	690 V
0,16 A	no additional current limiting device required up to highest fault currents			
0,25 A				
0,4 A				
0,63 A				
1 A				
1,6 A				
2,5 A				
4 A				
6,3 A				
10 A				
16 A	80	80	63	35
20 A	80	80	63	50
25 A	80	80	63	50

Back-up-protection BS					
overload release adjustment (A)	fuse (A)	overload release adjustment (A)	fuse (A)	overload release adjustment (A)	fuse (A)
0,4 - 0,63	2	2,5 - 4	10	16 - 20	50
0,63 - 1	4	4 - 6,3	16	20 - 25	50
1 - 1,6	6	6,3 - 10	25		
1,6 - 2,5	6	10 - 16	35		

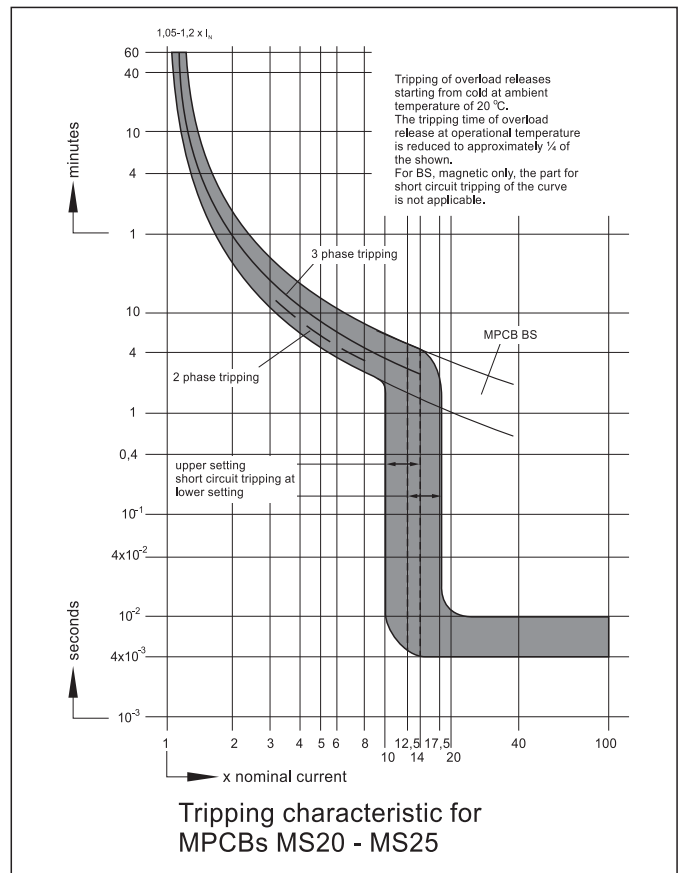
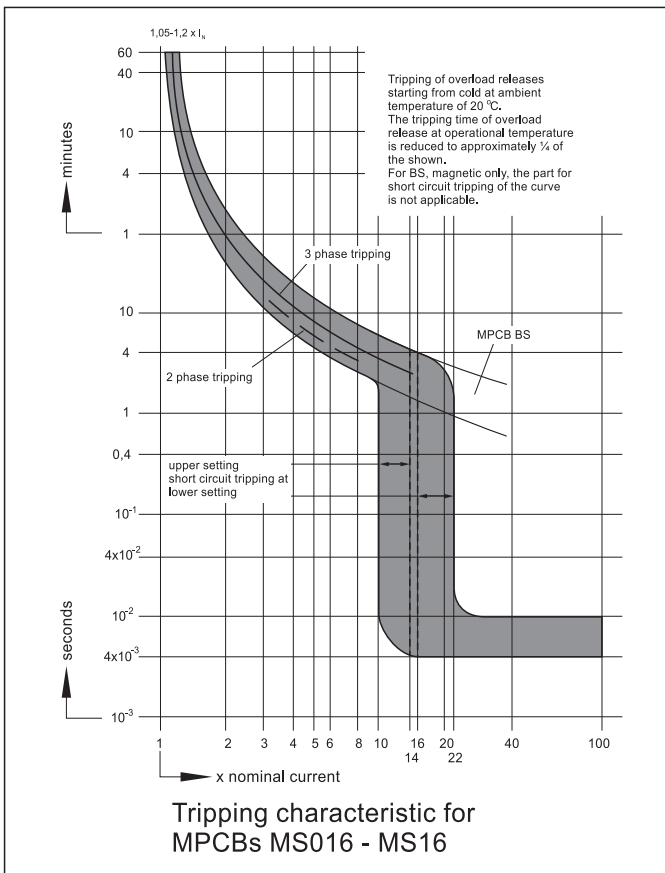

Motor Protective Circuit Breakers MS / BS / HMS

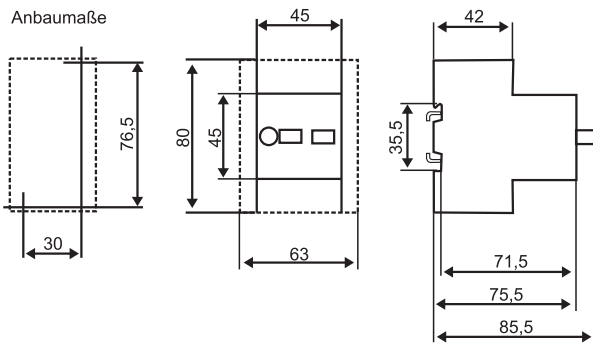

Current Limiter SBMS32

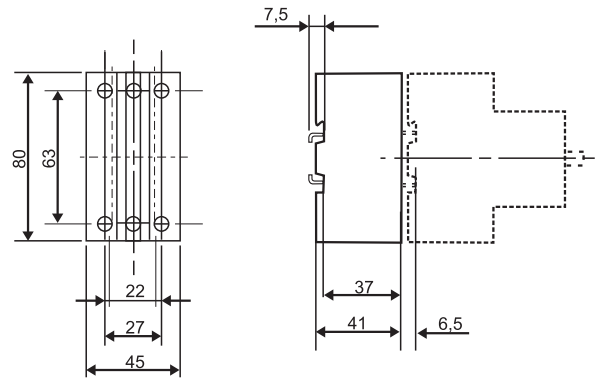

Insulated enclosure MS.G41 / MS.G55

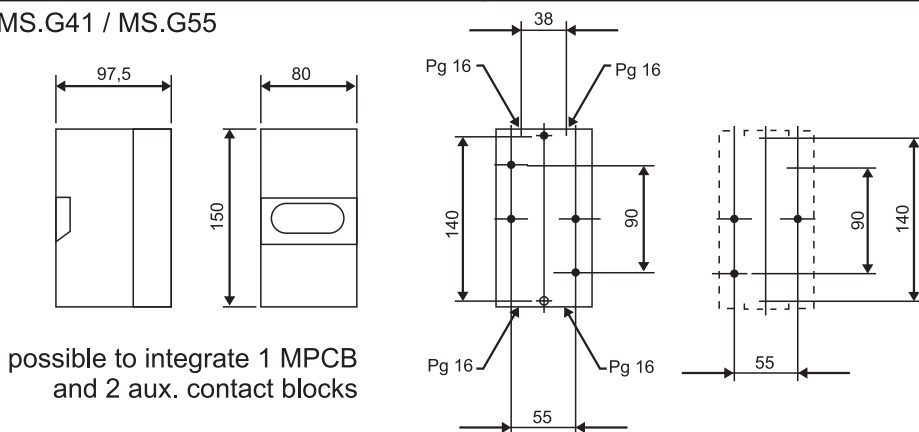

Flush mounting enclosure MS.F41 / MS.F55

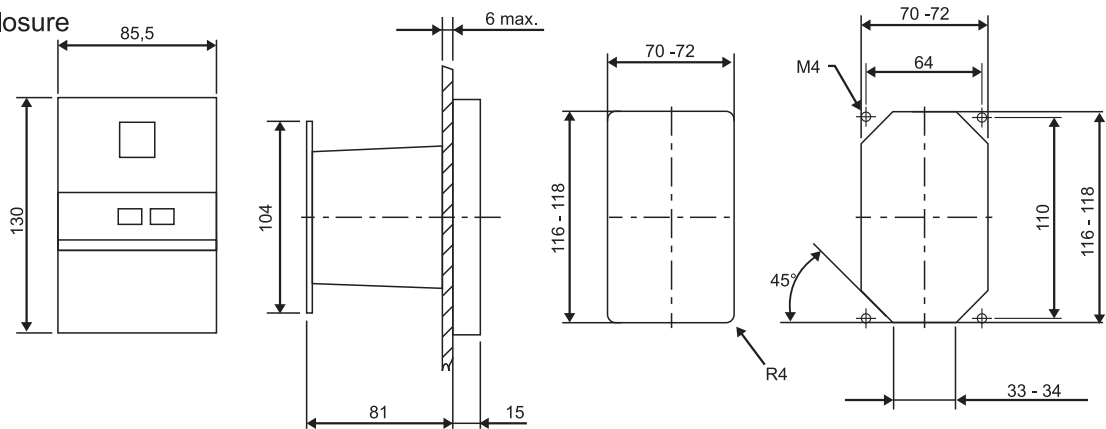

Insulated enclosures MS.C51/52 / MS.P51/52

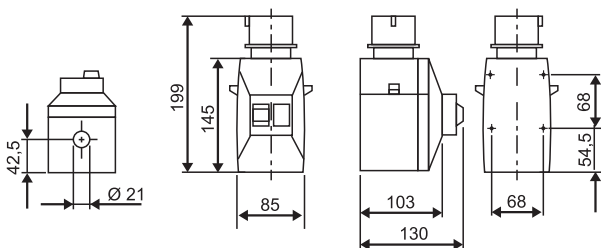

Emergency stop button MS.PT - PS.PS2

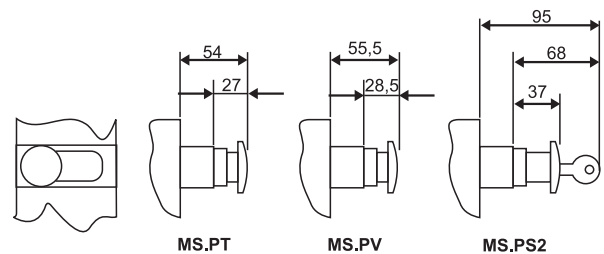

Nominal rated motor currents

Nominal rated motor currents of three-phase motors (recommended values for cage rotors)

Lowest possible fuse for three-phase motors

The max. value complies with the setting

The nominal rated motors currents are valid for interior- and surface cooled three-phase motors with 1500 r/min.

Direct starting: Starting current max. 6 x nominal rated motor current, starting time max. 5 s.

Y/Δ starting: Starting current max. 2 x nominal rated motor current, starting time max. 15 s.

Overload relays in line the winding have to be adjusted to 0,58 x nominal rated motor current.

Nominal rated current of fuses in case of Y/Δ starting are valid for slip-ring motors too.

At higher nominal rated currents, starting current and/or longer starting time bigger fuses have to be used.

The chart is valid for slow-acting respectively gI-fuses (DIN VDE 0636).

By using NH-fuses with aM-characteristics the size of the fuses = nominal rated current

Rating			230 V nominal rated motor current			400 V nominal rated motor current			500 V nominal rated motor current			690 V nominal rated motor current		
kW	cosφ	%	Fuse			Fuse			Fuse			Fuse		
			direct starting A	Y/Δ A	Y/Δ A	direct starting A	Y/Δ A	Y/Δ A	direct starting A	Y/Δ A	Y/Δ A	direct starting A	Y/Δ A	Y/Δ A
0,06	0,7	58	0,37	2	-	0,21	2	-	0,17	2	-	0,12	2	-
0,09	0,7	60	0,54	2	-	0,31	2	-	0,25	2	-	0,18	2	-
0,12	0,7	60	0,72	4	2	0,41	2	-	0,33	2	-	0,24	2	-
0,18	0,7	62	1,04	4	2	0,6	2	-	0,48	2	-	0,35	2	-
0,25	0,7	62	1,4	4	2	0,8	4	2	0,7	2	-	0,43	2	-
0,37	0,72	62	2	6	4	1,2	4	2	0,9	2	2	0,7	2	-
0,55	0,75	69	2,7	10	4	1,5	4	2	1,2	4	2	0,9	4	2
0,75	0,78	74	3,2	10	4	1,9	6	4	1,5	4	2	1,1	4	2
1,1	0,81	74	4,6	10	6	2,6	6	4	2,1	6	4	1,5	4	2
1,5	0,81	74	6,3	16	10	3,6	6	4	2,9	6	4	2,1	6	4
2,2	0,81	78	8,7	20	10	5	10	6	4	10	4	2,9	10	4
3	0,82	80	11,5	25	16	6,6	16	10	5,3	16	6	3,8	10	4
4	0,82	83	14,8	32	16	8,5	20	10	6,8	16	10	4,9	16	6
5,5	0,82	86	19,6	32	25	11,3	25	16	9	20	16	6,5	16	10
7,5	0,82	87	26,4	50	32	15,2	32	16	12,1	25	16	8,8	20	10
11	0,84	87	38	80	40	21,7	40	25	17,4	32	20	12,6	25	16
15	0,84	88	51	100	63	29,3	63	32	23,4	50	25	17	32	20
18,5	0,84	88	63	125	80	36	63	40	28,9	50	32	20,9	32	25
22	0,84	92	71	125	80	41	80	50	33	63	32	23,8	50	25
30	0,85	92	96	200	100	55	100	63	44	80	50	32	63	32
37	0,86	92	117	200	125	68	125	80	54	100	63	39	80	50
45	0,86	93	141	250	160	81	160	100	65	125	80	47	80	63
55	0,86	93	173	250	200	99	200	125	79	160	80	58	100	63
75	0,86	94	233	315	250	134	200	160	107	200	125	78	160	100
90	0,86	94	279	400	315	161	250	200	129	200	160	93	160	100
110	0,86	94	342	500	400	196	315	200	157	250	160	114	200	125
132	0,87	95	401	630	500	231	400	250	184	250	200	134	250	160
160	0,87	95	486	630	630	279	400	315	224	315	250	162	250	200
200	0,87	95	607	800	630	349	500	400	279	400	315	202	315	250
250	0,87	95	-	-	-	437	630	500	349	500	400	253	400	315
315	0,87	96	-	-	-	544	800	630	436	630	500	316	500	400
400	0,88	96	-	-	-	683	1000	800	547	800	630	396	630	400
450	0,88	96	-	-	-	769	1000	800	615	800	630	446	630	630
500	0,88	97	-	-	-	-	-	-	-	-	-	491	630	630
560	0,88	97	-	-	-	-	-	-	-	-	-	550	800	630
630	0,88	97	-	-	-	-	-	-	-	-	-	618	800	630

Technical Data	
Standards	IEC 947, EN 60947, DIN VDE 0660
Approvals	cULus, DIN VDE, SEV
Mechanical lifespan = electrical lifespan	0,1 x 10 ⁶ operations
Max. operating frequency	30 operations / h
Ambient temperature in free air, max./min. enclosed, max./ min.	+55° C / -20° C +40° C / -20° C
Mechanical shock resistance	15 g / 10 ms
Mounting position	normally any, in IP 41 enclosure vertical
Cross section (1 or 2 conductors)	1,0 - 4 solid, 0,75 - 2,5 stranded cable with termination max. 2 conductors differing by not than 2 sizes
Tightening torque for terminal screws main terminals auxiliary terminals	1,2 Nm 1,0 Nm
Rated impulse withstand voltage U _{imp}	6000 V
Overvoltage category / pollution level	III/3
Rated operational voltage U _e	690 V
Rated operational current I _e	0,16 - 25 A according to setting range
Rated operational frequency	40...60 Hz AC-3 max. 690V
Temperature compensation reference values to IEC, DIN VDE	-5° C / +40° C
Temperature compensation operating range	-20° C...+55° C
Phase failure sensitivity	IEC 947-4-1, DIN VDE 0660 Part 102

Rated short circuit breaking capacity I_{cu} MS IEC 60947-2, EN 60947-2

overload release adjustment	I _{cu} (kA)				Breaking capacity with current limiter SBMS32 I _{cu} (kA)	
	230 V	400 V	500 V	690 V	230 V	400 V
0,16 - 1,6 A	no additional current limiting device required up to highest fault currents				no additional current limiting device required up to highest fault currents	
2,5 - 6,3 A			3	2,5		
10 A		6	3	2,5		50
16 - 25 A	10	6	2,5	2	100	50

Switching times at short circuit

minimum command time	2 ms
opening delay	2 ms
opening time	7 ms

Other Products Available

- Control & signaling devices Ø 22.5mm & Ø 30.5mm
- Pilot lights & illuminated push buttons with LED
- Control stations (aluminium / plastic)
- Inductive proximity switches
- Single / Multiple limit switches
- Switches for appliances
- Rocker switches
- Micro switches
- Circuit breaker for equipment
- Isolators / Safety switches
- Switch Fuse units / Switch Disconnectors
- Load Break Switches
- Tower Lights
- Cable Conduits
- Cable Chain Carrier
- LED Lighting Fittings
- MCBS, RCCBS, RCBOS
- Distribution Boards for MCBS
- Industrial Plugs & Sockets
- Distribution Assemblies & Cable Reels

Control Stations



Load Break Switches,
Fuse Switch Disconnectors,
Switchfuse Units, Change Over Switches

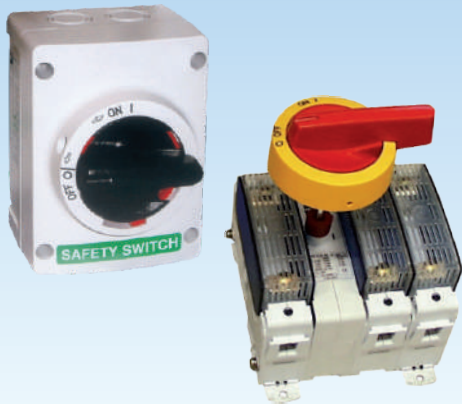

Motor Protective Circuit Breaker TMP65



Insulated Enclosure

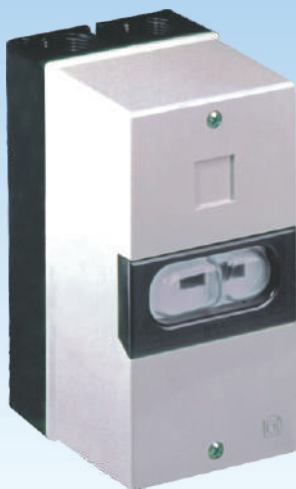

Enclosure



Side auxiliary
contact block
TACBS



Trip signalling block
TTSB

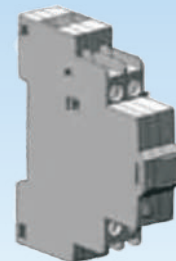

Compact Starters

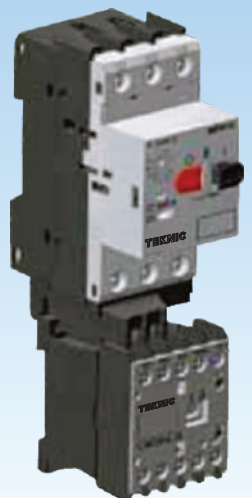

TEKNIC

703, Madhava, Bandra Kurla Complex, Bandra East, Mumbai 400 051.
Tel.: 022-26592392, 42532500 Fax: 022-26592391 Email: teknico@vsnl.com Web: www.teknico.co.in

