

**Model No.:** R10-R33964-Y

**Description:** Ammeter Rotary Cam Switch, 10A, Current in each phase with OFF



### Salient Features:

- Quick installation
- Safe operation
- Robust design
- Used for measuring application
- Wide application e.g. elevator industries, motor control, automation, machineries etc
- Optimum performance
- Choice of multiposition/multiple circuits
- Current in each phase with OFF

### General Characteristics:

It's a manual cam operated control switch assembled on packet principle with wide application in electrical, electronics & instrumentation equipments. It is available with three packets. Plastic Cam is used for making breaking depending upon contact sequence. The Cam, which closes and opens the contacts, has rotary movement to multiple positions, thereby multiple Circuit functions can be controlled. It is suitable for AC switching applications. The shorting links assembled in the rotary cam switch are not to be removed to ensure proper functioning & sequencing of the Rotary Cam switch.

#### Construction:

Each packet has two sets of double break silver nickel contact for effective making & breaking. Packets are made from insulating material that can withstand mechanical & electrical stresses & have excellent electrical properties.

**Switching angle:** It is used to perform Make and Break operation in a sequential way by rotating the switch to different positions. Switching angle is 90.

**Mounting:** Available in panel mounting version. Fixing centers are: 36X36 & 25X30

**Warranty:** 18/12 month from the date of supply/uses, whichever is earlier.

#### Connections:

3	A1	11 - 12	X		X-X	
	A2	R 9 - 10		X		
2		7 - 8	X-X		X	
	Y	5 - 6			X	
1		3 - 4	X-X-X			
	B	1 - 2			X	
Disc	Terminal Marking	Contact	0	R	Y	B
			Position			

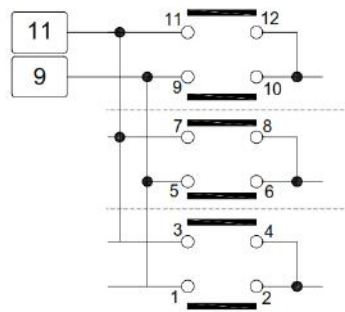
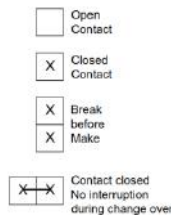

**Wiring Diagram**

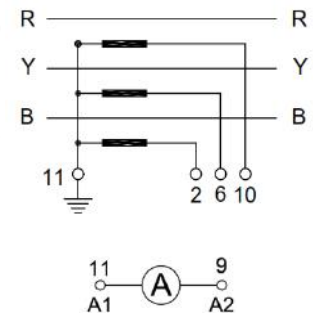

Available types		: Flange available in yellow & black. Knobs available in regular & extended type in red & black.
Degree of protection		: IP40 as per IEC 60529 : IP65 as per IEC 60529 with Gasket provided on request
Degree of Pollution		: 3
Applicable standards		: IEC 60947-3 : IEC 60204-1
Product Certification		: as per IEC 60947-3

### Mechanical Characteristics:

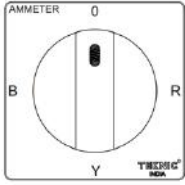
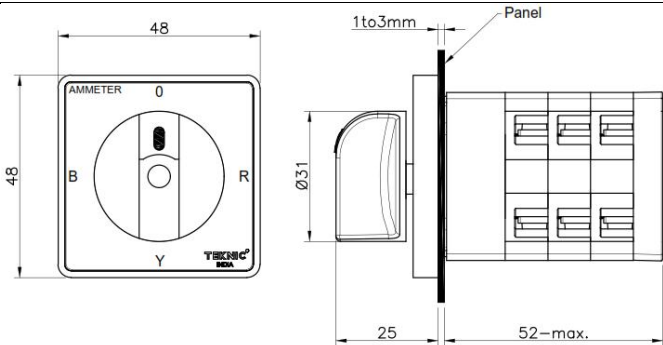
Function indicator		
Terminal Capacity		: Maximum 2 X 0.75mm <sup>2</sup> ; 2 X 1.5mm <sup>2</sup> : Minimum 1 X 0.5 mm <sup>2</sup>
Terminal marking		: R Y B A1 A2
Terminal Torque	Nm	: 0.8
Contact material		: Brass (for regular applications) : Contact material for Low voltage/Low Current options available on request
Operation		: Slow break (NO/NC)
Operating torque	Nm	: 11
Operating force	N	: NA
Positive operation Conforming to IEC/EN 60947-5-1 Appendix K		: All functions incorporating a NC contact are positive opening operation
Operating travel	mm	: NA
Mechanical life		: 2,00,000 operations
Ambient	°C	: -25 to +70
Storage	°C	: -25 to +40
Overall Dimensions with sketch (LXBXH)	mm	
Vibration resistance Conforming to IEC 60068-2-6	Hz	: Pending
Shock resistance Conforming to IEC 60068-2-27		: Pending
Viewing Angle	°	NA
Optical Axial intensity	mcd	NA
Weight	gms	:

### Electrical Characteristics of contacts:

Make & Break Capacity		Utilization category	AC21
		Rating	10A 3phase 415V 10A
Rated insulation voltage	V		: 500
Rated thermal current	A		: 12
Low power application			: Low voltage/Low Current options for infrequent applications available on request (<25mA)
Short circuit protection			: NA
Dielectric Test	KV		: 2.5
Approvals regarding the part:			: as per IEC 60947-3
Approvals regarding the material			
Polymeric parts			: UL-Recognized material
Rated Impulse Withstand			: NA
Polarity protection			: NA
Current Consumption	mA		: NA
Electrical Endurance			: at rated current over 50000 operations

### Accessories & codes:

NA

### Ordering codes

The ordering code for each product is mentioned in the Catalogue/Data Sheet and not indicated on each product because of the various combinations possible it becomes practically impossible to do so. However the primary packing box always mentions the ordering code of the material it holds.

E.g. R10-R33964-Y

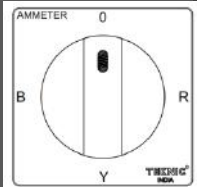
<u>R10-</u>	<u>R</u>	<u>3</u>	<u>3</u>	<u>9</u>	<u>64</u>	<u>-Y</u>						
↓	↓	↓	↓	↓	↓	↓						
<b>Rotary Cam Switch 10A</b>	<b>Number of Ways</b>	<b>Number of poles per position</b>	<b>No of discs</b>	<b>Degree of rotation</b>	<b>Combinations of Legends &amp; Functions</b>	<b>Knob plate combination</b>						
	R=Ammeter			9=90°with OFF		<table border="0"> <tr> <td style="text-align: center;"><u>Code</u></td> <td style="text-align: center;"><u>Knob</u></td> <td style="text-align: center;"><u>Plate</u></td> </tr> <tr> <td style="text-align: center;">Y</td> <td style="text-align: center;">Regular Red</td> <td style="text-align: center;">Yellow</td> </tr> </table>	<u>Code</u>	<u>Knob</u>	<u>Plate</u>	Y	Regular Red	Yellow
<u>Code</u>	<u>Knob</u>	<u>Plate</u>										
Y	Regular Red	Yellow										

### Mounting Instructions:

Safety regulations: This unit may be installed & commissioned by personnel who are familiar with current regulation for health & safety at work & accident prevention. Ensure local regulations are met especially those relating to safety. Ensure that this Rotary Cam switch will operate fully after installation. Failure to follow these will result in death or serious injury.

### Mounting

- : Fixing Centers: 30mm X 25mm Min.
- : Fixing Centers: 36mm X 36mm min.
- : Mounting Panel thickness: 1mm to 3mm

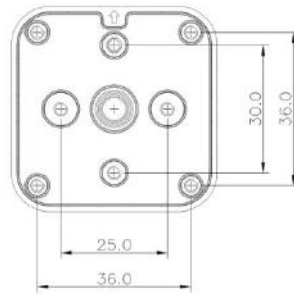

Switch Mounting Details

8 holes - for self threading screw - M3x9 mm

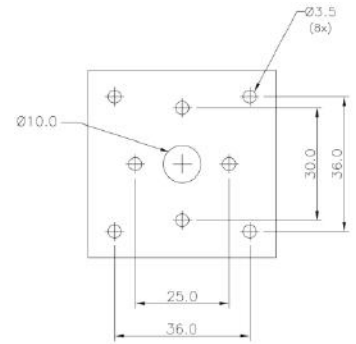

Drilling Plan

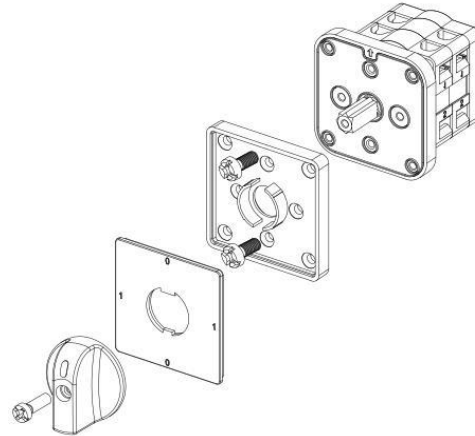

No of elements possible

: 3 Packets

### To install:

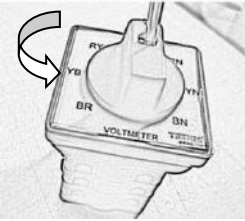

Remove the screw on the knob by turning in anticlockwise direction

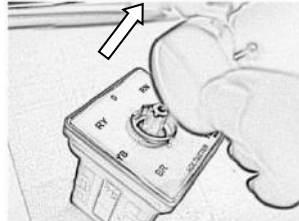

Remove the knob by pulling it up

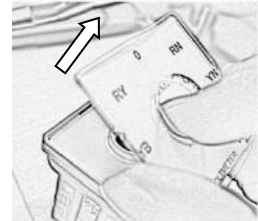

Remove the transparent legend plate taking care of the markings on it

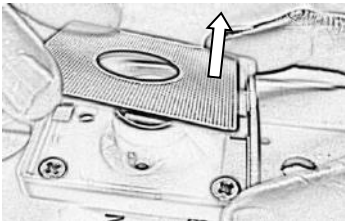

Remove the opaque inner plate

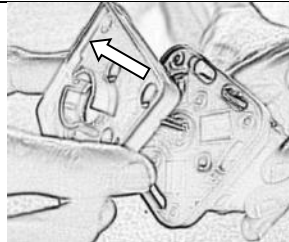

Remove the yellow flush plate

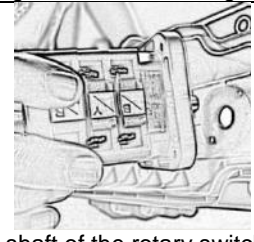

Align the shaft of the rotary switch with the panel hole.

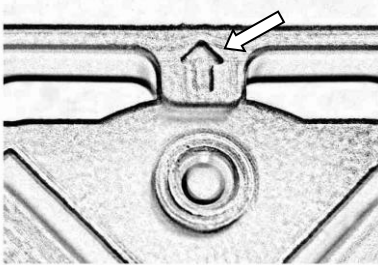

Align the arrow on the rotary cam switch body top position on the panel

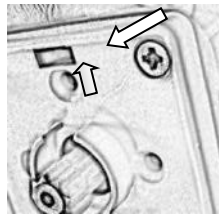

Align the arrow of the yellow flush plate with the arrow. Mount the yellow flush plate from above the panel.

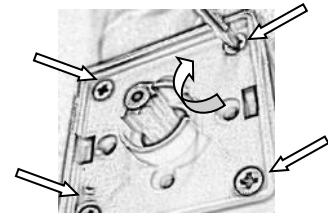

Tighten the panel fixing screws provided with the switch as a kit

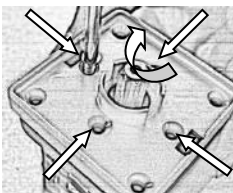

Alternatively you may use the other four holes for fixing the screws

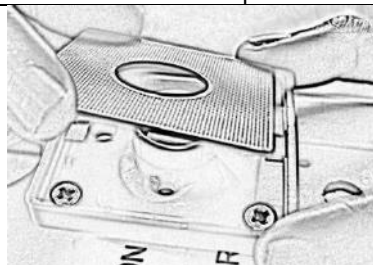

Place the opaque inner plate back on the yellow flush plate

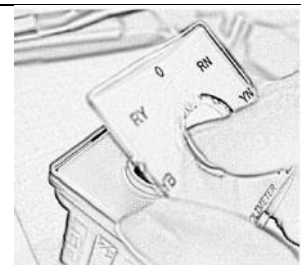

Place the transparent legend plate taking care of the projections provided & the readability of the legends

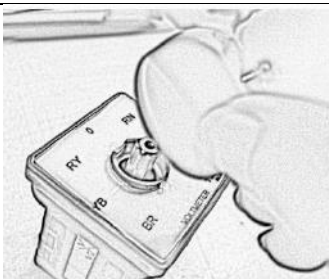

Place back the selector knob

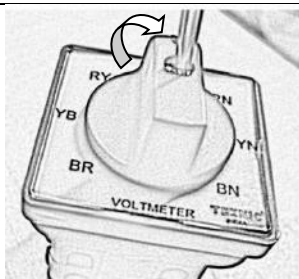

Tighten the screw of the selector knob in clockwise direction with a torque of 1.2Nm

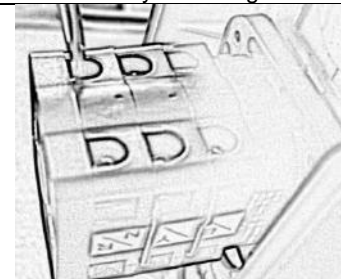

The unit is ready for wiring

### To uninstall:

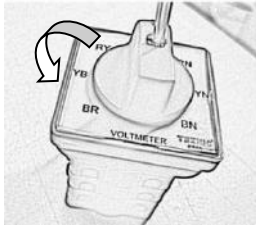

Remove the wiring. Remove the screw on the knob by turning in anticlockwise direction

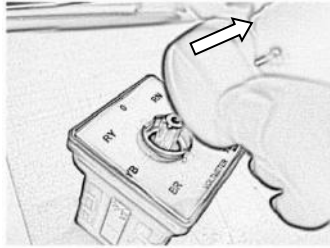

Remove the knob by pulling it up

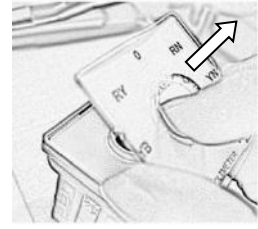

Remove the transparent legend plate taking care of the markings on it

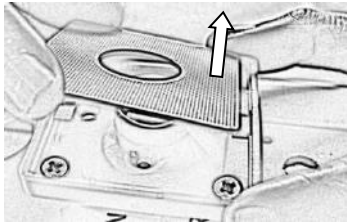

Remove the opaque inner plate

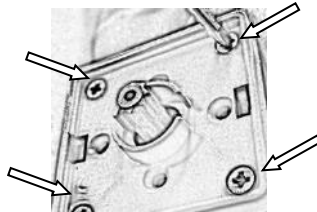

Remove the panel fixing screws

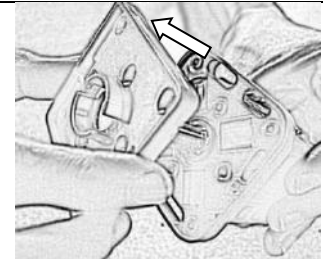

Remove the yellow flush plate

If any more information is required, kindly contact our Marketing Department at +91-22-42532500 or email at [ram.talreja@teknico.in](mailto:ram.talreja@teknico.in)